

ARS-2000 USER

Intel® Core™ i7/i5/i3 SoC (Kaby Lake) Fanless Embedded Box PC,
M12 PoE+, Isolated COM, PCI/PCIe Slot, DIN Rail Mount, -40°C to 75°C

Manual

Record of Revision

Version	Date	Page	Description	Remark
1.00	12/08/2017	All	Official Release	
1.10	02/03/2020	27	Update	
1.20	09/16/2020	Cover, 2-13	Update	
1.30	03/23/2021	3, 5, 7, 9, 11, 13, 31	Update	
1.40	06/13/2023	vi, 17, 46, 97	Update	
1.50	06/29/2023	107-109	Update	

Disclaimer

This manual is released by Vecow Co., Ltd. for reference purpose only. All product offerings and specifications are subject to change without prior notice. It does not represent commitment of Vecow Co., Ltd. Vecow shall not be liable for direct, indirect, special, incidental, or consequential damages arising out of the use of the product or documentation or any infringements upon the rights of third parties, which may result from such use.

Declaration of Conformity

FCC This equipment has been tested and found to comply with the limits for a Class A digital device, pursuant to part 15 of the FCC Rules. These limits are designed to provide reasonable protection against harmful interference when the equipment is operated in a commercial environment. This equipment generates, uses, and can radiate radio frequency energy, and if it is not installed and used in accordance with the instruction manual, it may cause harmful interference to radio communications. Operation of this equipment in a residential area is likely to cause harmful interference in which case the user will be required to correct the interference at his own expense.

CE The products described in this manual complies with all applicable European Union (CE) directives if it has a CE marking. For computer systems to remain CE compliant, only CE-compliant parts may be used. Maintaining CE compliance also requires proper cable and cabling techniques.

Copyright and Trademarks

This document contains proprietary information protected by copyright. No part of this publication may be reproduced in any form or by any means, electric, photocopying, recording or otherwise, without prior written authorization by Vecow Co., Ltd. The rights of all the brand names, product names, and trademarks belong to their respective owners.

Order Information

Part Number	Description
ARS-2010M-7600U	ARS-2000, Intel® Core™ i7-7600U, 3 GigE LAN w/2 M12 PoE ⁺ , 1 PCIe x4, 4 COM, 4 USB 3.0, 32 Isolated DIO
ARS-2010M-600U	ARS-2000, Intel® Core™ i7-6600U, 3 GigE LAN w/2 M12 PoE ⁺ , 1 PCIe x4, 4 COM, 4 USB 3.0, 32 Isolated DIO
ARS-2010M-300U	ARS-2000, Intel® Core™ i5-6300U, 3 GigE LAN w/2 M12 PoE ⁺ , 1 PCIe x4, 4 COM, 4 USB 3.0, 32 Isolated DIO
ARS-2010M-955U	ARS-2000, Intel® Celeron® 3955U, 3 GigE LAN w/2 M12 PoE ⁺ , 1 PCIe x4, 4 COM, 4 USB 3.0, 32 Isolated DIO
ARS-2010-7600U	ARS-2000, Intel® Core™ i7-7600U, 3 GigE LAN w/2 PoE ⁺ , 1 PCIe x4, 4 COM, 4 USB 3.0, 32 Isolated DIO
ARS-2010-600U	ARS-2000, Intel® Core™ i7-6600U, 3 GigE LAN w/2 PoE ⁺ , 1 PCIe x4, 4 COM, 4 USB 3.0, 32 Isolated DIO
ARS-2010-300U	ARS-2000, Intel® Core™ i5-6300U, 3 GigE LAN w/2 PoE ⁺ , 1 PCIe x4, 4 COM, 4 USB 3.0, 32 Isolated DIO
ARS-2010-955U	ARS-2000, Intel® Celeron® 3955U, 3 GigE LAN w/2 PoE ⁺ , 1 PCIe x4, 4 COM, 4 USB 3.0, 32 Isolated DIO
ARS-2001M-7600U	ARS-2000, Intel® Core™ i7-7600U, 3 GigE LAN w/2 M12 PoE ⁺ , 1 PCI, 4 COM, 4 USB 3.0, 32 Isolated DIO
ARS-2001M-600U	ARS-2000, Intel® Core™ i7-6600U, 3 GigE LAN w/2 M12 PoE ⁺ , 1 PCI, 4 COM, 4 USB 3.0, 32 Isolated DIO
ARS-2001M-300U	ARS-2000, Intel® Core™ i5-6300U, 3 GigE LAN w/2 M12 PoE ⁺ , 1 PCI, 4 COM, 4 USB 3.0, 32 Isolated DIO
ARS-2001M-955U	ARS-2000, Intel® Celeron® 3955U, 3 GigE LAN w/2 M12 PoE ⁺ , 1 PCI, 4 COM, 4 USB 3.0, 32 Isolated DIO
ARS-2001-7600U	ARS-2000, Intel® Core™ i7-7600U, 3 GigE LAN w/2 PoE ⁺ , 1 PCI, 4 COM, 4 USB 3.0, 32 Isolated DIO
ARS-2001-600U	ARS-2000, Intel® Core™ i7-6600U, 3 GigE LAN w/2 PoE ⁺ , 1 PCI, 4 COM, 4 USB 3.0, 32 Isolated DIO
ARS-2001-300U	ARS-2000, Intel® Core™ i5-6300U, 3 GigE LAN w/2 PoE ⁺ , 1 PCI, 4 COM, 4 USB 3.0, 32 Isolated DIO
ARS-2001-955U	ARS-2000, Intel® Celeron® 3955U, 3 GigE LAN w/2 PoE ⁺ , 1 PCI, 4 COM, 4 USB 3.0, 32 Isolated DIO
ARS-2000ML-7600U	ARS-2000, Intel® Core™ i7-7600U, 3 GigE LAN w/2 M12 PoE ⁺ , 2 COM, 4 USB 3.0, 32 GPIO
ARS-2000ML-600U	ARS-2000, Intel® Core™ i7-6600U, 3 GigE LAN w/2 M12 PoE ⁺ , 2 COM, 4 USB 3.0, 32 GPIO
ARS-2000ML-300U	ARS-2000, Intel® Core™ i5-6300U, 3 GigE LAN w/2 M12 PoE ⁺ , 2 COM, 4 USB 3.0, 32 GPIO
ARS-2000ML-955U	ARS-2000, Intel® Celeron® 3955U, 3 GigE LAN w/2 M12 PoE ⁺ , 2 COM, 4 USB 3.0, 32 GPIO

ARS-2000L-7600U	ARS-2000, Intel® Core™ i7-7600U, 3 GigE LAN w/2 PoE+, 2 COM, 4 USB 3.0, 32 GPIO
ARS-2000L-600U	ARS-2000, Intel® Core™ i7-6600U, 3 GigE LAN w/2 PoE+, 2 COM, 4 USB 3.0, 32 GPIO
ARS-2000L-300U	ARS-2000, Intel® Core™ i5-6300U, 3 GigE LAN w/2 PoE+, 2 COM, 4 USB 3.0, 32 GPIO
ARS-2000L-955U	ARS-2000, Intel® Celeron® 3955U, 3 GigE LAN w/2 PoE+, 2 COM, 4 USB 3.0, 32 GPIO

Order Accessories

Part Number	Description
DDR4 16G	Certified DDR4 16GB 2133MHz RAM
DDR4 8G	Certified DDR4 8GB 2133MHz RAM
DDR4 4G	Certified DDR4 4GB 2133MHz RAM
PWA-280WB-WT	280W, 24V, 85V AC to 264V AC Power Adapter with 3-pin Terminal Block, Wide Temperature -30°C to +70°C
PWA-160WB-WT	160W, 24V, 85V AC to 264V AC Power Adapter with 3-pin Terminal Block, Wide Temperature -30°C to +70°C
PWA-120W	120W, 24V, 90V AC to 264V AC Power Adapter with 3-pin Terminal Block
DIN-RAIL	DIN Rail Kit
TMK2-20P-100	Terminal Block 20-pin to Terminal Block 20-pin Cable, 100cm
TMK2-20P-500	Terminal Block 20-pin to Terminal Block 20-pin Cable, 500cm
TMB-TMBK-20P	Terminal Board with One 20-pin Terminal Block Connector and DIN-Rail Mounting
4G Module	Mini PCIe 4G/GPS Module with Antenna
WiFi & Bluetooth Module	Mini PCIe WiFi & Bluetooth Module with Antenna

Table of Contents

CHAPTER 1	GENERAL INTRODUCTION	1
1.1	Overview	1
1.2	Features	2
1.3	Product Specification	2
1.3.1	Specifications of ARS-2010M	2
1.3.2	Specifications of ARS-2010	4
1.3.3	Specifications of ARS-2001M	6
1.3.4	Specifications of ARS-2001	8
1.3.5	Specifications of ARS-2000ML	10
1.3.6	Specifications of ARS-2000L	12
1.4	Supported CPU List	14
1.5	Mechanical Dimension	15
1.5.1	Dimensions of ARS-2010M/2001M	15
1.5.2	Dimensions of ARS-2010/2001	15
1.5.3	Dimensions of ARS-2000ML	16
1.5.4	Dimensions of ARS-2000L	16
CHAPTER 2	GETTING TO KNOW YOUR ARS-2000	17
2.1	Packing List	17
2.2	Front Panel I/O & Functions	18
2.3	Top Panel I/O & Functions	28
2.4	Bottom Panel I/O & Functions	32
2.5	Main Board Expansion Connectors	37
2.6	Main Board Jumper & DIP Switch Settings	46
2.7	Ignition Control	50
CHAPTER 3	SYSTEM SETUP	54
3.1	How to Open Your ARS-2000	54
3.2	Installing DDR4 SO-DIMM Module	56
3.3	Installing Mini PCIe Card	57

3.4	Installing Antenna Cable	58
3.5	Installing CFast Card	59
3.6	Installing SIM Card	60
3.7	Installing SSD/HDD	61
3.8	Installing PCI/PCIe Card (NOT for LIGHT version)	62
3.9	Mounting Your ARS-2000	64
CHAPTER 4	BIOS SETUP	66
4.1	Entering BIOS SETUP	66
4.2	Main	67
4.3	Advanced	67
4.4	Chipset	78
4.5	Security	82
4.6	Boot	84
4.7	Save & Exit	85
APPENDIX A	Isolated DIO Guide	86
APPENDIX B	Software Functions	91
APPENDIX C	RAID Installation Guide	95
APPENDIX D	Power Consumption	100
APPENDIX E	Supported Memory & Storage List	104
APPENDIX F	Install Win11 (BIOS TPM Setting)	107

1

GENERAL INTRODUCTION

1.1 Overview

Vecow ARS-2000 is a performance-driven compact integrated Fanless Embedded System. Powered by 7th Generation Intel® Core™ i7/i5/i3 SoC (Kaby Lake-U/Skylake-U), dual channel DDR4 2133MHz memory, up to 32GB, ARS-2000 Series Embedded Box PC delivers up to 84.5% enhanced CPU performance than the former generation, Vecow ARS-1000 Compact Embedded System. Advanced Intel® HD Graphics 620/520 graphics engine supports DirectX 12, OpenGL 4.4 and OpenCL 2.0 API, onboard DVI-D and DVI-I display interfaces. Multiple Gen 3 PCIe (8GT/s), SATA III (6Gbps), USB 3.0 (5Gbps), GigE (1Gbps) LAN and flexible WiFi/3G/4G/LTE/GPS/GPRS/UMTS wireless connections make high-speed data transmission possible.

All-in-one fanless -40°C to 85°C extended operating temperature, 3 independent GigE LANs with 2-port M12 IEEE 802.3at PoE⁺ support iAMT 11.0; 4-port COM RS-232/422/485 with 1 Isolated COM RS-232/422/485; 1 PCI/PCIe x4 expansion slot for variety of additional functions : independent graphics, multiple 10 GigE LAN ports, dual LAN Bypass, multiple PoE⁺ ports or multiple USB ports ; 4 external USB 3.0, 1 SIM card socket for 3G/4G/LTE/WiFi/GPRS/UMTS, 2 SATA III support up to 2 2.5" SSD, 32 Isolated DIO; 6V to 36V wide range power input with 80V Surge Protection, Ignition Power Control; CE, FCC, EN50155 and EN50121-3-2 compliant, Vecow ARS-2000 Series Compact Embedded Box PC integrates outstanding performance, remarkable power productivity, smart manageability, mobile availability and extremely rugged reliability for performance-driven embedded applications.

With 7th Generation Intel® Core™ i7/i5/i3 SoC (Kaby Lake-U/Skylake-U) engine, fanless -40°C to 85°C operating temperature, 3 GigE LAN with 2 M12 IEEE 802.3at PoE⁺, 32 Isolated DIO, 1 Isolated COM, 1 PCI/PCIe x4 for additional expansion functions, 6V to 36V power input with 80V surge protection, ignition power control, all-in-one compact integrated features supporting DIN Rail Mount, Vecow ARS-2000 Series Fanless PC is your compact & rugged solution for Machine Vision, Smart Manufacturing, Intelligent Control, Factory Automation, Intelligent Surveillance, and any Industry 4.0/IIoT applications in harsh environments.

1.2 Features

- Intel® Core™ i7/i5/i3 U-series SoC (Kaby Lake-U/Skylake-U)
- 3 Independent GigE LAN with 2 M12 IEEE 802.3at PoE⁺
- Rugged, Fanless -40°C to 85°C Operation
- 4 USB 3.0, 2 SATA III, 2 Mini PCIe, 1PCI/PCIe x4 expansion
- 4/2 COM RS-232/422/485 with 1 Isolated COM
- Supports DVI-I and DVI-D dual HD displays
- External SIM Socket for WiFi/3G/4G/LTE/GPRS/UMTS
- 6V to 36V DC-in with 80V Surge Protection
- 32 Isolated DIO/32 GPIO, Ignition Power Control
- Mounting : DIN Rail, Wallmount

1.3 Product Specification

1.3.1 Specifications of ARS-2010M

System	
Processor	Intel® Core™ i7/i5/i3 U-series Processor (Kaby Lake-U/Skylake-U)
Chipset	Intel® SoC
BIOS	AMI
SIO	IT8786E
Memory	<ul style="list-style-type: none">• DDR4 2133MHz• Up to 64GB• 2 260-pin SO-DIMM Socket
I/O Interface	
Serial	<ul style="list-style-type: none">• 1 Isolated COM RS-232/422/485 (2.5kV Isolation)• 3 COM RS-232/422/485
USB	4 USB 3.0 (External)
Isolated DIO	32 Isolated DIO (16 DI, 16 DO) , support NPN/PNP
LED	Power, HDD, Wireless, PoE
SIM Card	1 SIM Card Socket (External)
Expansion	
Mini PCIe	2 Mini PCIe Socket : <ul style="list-style-type: none">• 1 Full-size for PCIe/USB/mSATA• 1 Full-size for PCIe/USB/External SIM Card
PCI/PCIe	1 PCIe x16 Slot supports x4 Signal

Graphics	
Graphics Processor	<ul style="list-style-type: none"> • Intel® HD Graphics 620/520
Interface	<ul style="list-style-type: none"> • DVI-I : Up to 1920 x 1200 @ 60Hz • DVI-D : Up to 1920 x 1200 @ 60Hz
Storage	
SATA	2 SATA III (6Gbps) support S/W RAID 0, 1 : <ul style="list-style-type: none"> • 1 SATA III (6Gbps) • 1 SATA III co-lay with Mini PCIe (6Gbps)
mSATA	1 SATA III co-lay with SATA (Mini PCIe Type, 6Gbps)
Storage Device	<ul style="list-style-type: none"> • 1 CFAST Socket, Push-in/Push-out Ejector • 2 2.5" SSD/HDD Bracket (Internal)
Audio	
Audio Codec	Realtek ALC888S-VD, 7.1 Channel HD Audio
Audio Interface	1 Mic-in, 1 Line-out
Ethernet	
LAN 1	Intel® I219LM GigE LAN supports iAMT 11.0
PoE	
LAN 2	GigE IEEE 802.3at (25.5W/48V) PoE+ by Intel® I210 with Power On/Off Control, M12 Connector
LAN 3	GigE IEEE 802.3at (25.5W/48V) PoE+ by Intel® I210 with Power On/Off Control, M12 Connector
Power	
Input Voltage	6V to 36V, DC-in
Power Interface	3-pin Terminal Block : V+, V-, Frame Ground
Ignition Control	16 Mode (Internal)
Remote Switch	3-pin Terminal Block : On, Off, IGN
Surge Protection	Up to 80V/1ms Transient Power
Others	
TPM	Optional Infineon SLB9665 supports TPM 2.0, LPC interface
Watchdog Timer	Reset : 1 to 255 sec./min. per step
Smart Management	Wake on LAN, PXE supported
HW Monitor	Monitoring temperature, voltages. Auto throttling control when CPU overheats.
Software Support	
OS	Windows 10, Windows 8.1, Windows 7, Linux (Windows 8.1 & 7 are not available for Kaby Lake)

Mechanical	
Dimensions (WxDxH)	186mm x 147mm x 82mm (7.3" x 5.8" x 3.2")
Weight	2.2 kg (4.85 lb)
Mounting	<ul style="list-style-type: none"> • Wallmount by mounting bracket • DIN Rail Mount (Optional)
Environment	
Operating Temperature	-40°C to 75°C (-40°F to 185°F)
Storage Temperature	-40°C to 85°C (-40°F to 185°F)
Humidity	5% to 95% humidity, non-condensing
Relative Humidity	95% at 75°C
Shock	<ul style="list-style-type: none"> • IEC 60068-2-27 • SSD : 50G @ Wallmount, Half-sine, 11ms
Vibration	<ul style="list-style-type: none"> • IEC 60068-2-64 • SSD : 5Grms, 5Hz to 500Hz, 3 Axis
EMC	CE, FCC, EN50155, EN50121-3-2

1.3.2 Specifications of ARS-2010

System	
Processor	Intel® Core™ i7/i5/i3 U-series Processor (Kaby Lake-U/Skylake-U)
Chipset	Intel® SoC
BIOS	AMI
SIO	IT8786E
Memory	<ul style="list-style-type: none"> • DDR4 2133MHz • Up to 64GB • 2 260-pin SO-DIMM Socket
I/O Interface	
Serial	<ul style="list-style-type: none"> • 1 Isolated COM RS-232/422/485 (2.5kV Isolation) • 3 COM RS-232/422/485
USB	4 USB 3.0 (External)
Isolated DIO	32 Isolated DIO (16 DI, 16 DO) , support NPN/PNP
LED	Power, HDD, Wireless, PoE
SIM Card	1 SIM Card Socket (External)

Expansion	
Mini PCIe	2 Mini PCIe Socket : <ul style="list-style-type: none"> • 1 Full-size for PCIe/USB/mSATA • 1 Full-size for PCIe/USB/External SIM Card
PCI/PCIe	1 PCIe x16 Slot supports x4 Signal
Graphics	
Graphics Processor	• Intel® HD Graphics 620/520
Interface	• DVI-I : Up to 1920 x 1200 @ 60Hz • DVI-D : Up to 1920 x 1200 @ 60Hz
Storage	
SATA	2 SATA III (6Gbps) support S/W RAID 0, 1 : <ul style="list-style-type: none"> • 1 SATA III (6Gbps) • 1 SATA III co-lay with Mini PCIe (6Gbps)
mSATA	1 SATA III co-lay with SATA (Mini PCIe Type, 6Gbps)
Storage Device	• 1 CFast Socket, Push-in/Push-out Ejector • 2 2.5" SSD/HDD Bracket (Internal)
Audio	
Audio Codec	Realtek ALC888S-VD, 7.1 Channel HD Audio
Audio Interface	1 Mic-in, 1 Line-out
Ethernet	
LAN 1	Intel® I219LM GigE LAN supports iAMT 11.0
PoE	
LAN 2	GigE IEEE 802.3at (25.5W/48V) PoE ⁺ by Intel® I210 with Power On/Off Control
LAN 3	GigE IEEE 802.3at (25.5W/48V) PoE ⁺ by Intel® I210 with Power On/Off Control
Power	
Input Voltage	6V to 36V, DC-in
Power Interface	3-pin Terminal Block : V+, V-, Frame Ground
Ignition Control	16 Mode (Internal)
Remote Switch	3-pin Terminal Block : On, Off, IGN
Surge Protection	Up to 80V/1ms Transient Power
Others	
TPM	Optional Infineon SLB9665 supports TPM 2.0, LPC interface
Watchdog Timer	Reset : 1 to 255 sec./min. per step
Smart Management	Wake on LAN, PXE supported
HW Monitor	Monitoring temperature, voltages. Auto throttling control when CPU overheats.

Software Support	
OS	Windows 10, Windows 8.1, Windows 7, Linux (Windows 8.1 & 7 are not available for Kaby Lake)
Mechanical	
Dimensions (WxDxH)	186mm x 147mm x 82mm (7.3" x 5.8" x 3.2")
Weight	2.2 kg (4.85 lb)
Mounting	<ul style="list-style-type: none"> • Wallmount by mounting bracket • DIN Rail Mount (Optional)
Environment	
Operating Temperature	-40°C to 75°C (-40°F to 185°F)
Storage Temperature	-40°C to 85°C (-40°F to 185°F)
Humidity	5% to 95% humidity, non-condensing
Relative Humidity	95% at 75°C
Shock	<ul style="list-style-type: none"> • IEC 60068-2-27 • SSD : 50G @ Wallmount, Half-sine, 11ms
Vibration	<ul style="list-style-type: none"> • IEC 60068-2-64 • SSD : 5Grms, 5Hz to 500Hz, 3 Axis
EMC	CE, FCC, EN50155, EN50121-3-2

1.3.3 Specifications of ARS-2001M

System	
Processor	Intel® Core™ i7/i5/i3 U-series Processor (Kaby Lake-U/Skylake-U)
Chipset	Intel® SoC
BIOS	AMI
SIO	IT8786E
Memory	<ul style="list-style-type: none"> • DDR4 2133MHz • Up to 64GB • 2 260-pin SO-DIMM Socket
I/O Interface	
Serial	<ul style="list-style-type: none"> • 1 Isolated COM RS-232/422/485 (2.5kV Isolation) • 3 COM RS-232/422/485
USB	4 USB 3.0 (External)
Isolated DIO	32 Isolated DIO (16 DI, 16 DO) , support NPN/PNP
LED	Power, HDD, Wireless, PoE
SIM Card	1 SIM Card Socket (External)

Expansion	
Mini PCIe	2 Mini PCIe Socket : <ul style="list-style-type: none"> • 1 Full-size for PCIe/USB/mSATA • 1 Full-size for PCIe/USB/External SIM Card
PCI/PCIe	1 PCI Slot
Graphics	
Graphics Processor	<ul style="list-style-type: none"> • Intel® HD Graphics 620/520
Interface	<ul style="list-style-type: none"> • DVI-I : Up to 1920 x 1200 @ 60Hz • DVI-D : Up to 1920 x 1200 @ 60Hz
Storage	
SATA	2 SATA III (6Gbps) support S/W RAID 0, 1 : <ul style="list-style-type: none"> • 1 SATA III (6Gbps) • 1 SATA III co-lay with Mini PCIe (6Gbps)
mSATA	1 SATA III co-lay with SATA (Mini PCIe Type, 6Gbps)
Storage Device	<ul style="list-style-type: none"> • 1 CFAST Socket, Push-in/Push-out Ejector • 2 2.5" SSD/HDD Bracket (Internal)
Audio	
Audio Codec	Realtek ALC888S-VD, 7.1 Channel HD Audio
Audio Interface	1 Mic-in, 1 Line-out
Ethernet	
LAN 1	Intel® I219LM GigE LAN supports iAMT 11.0
PoE	
LAN 2	GigE IEEE 802.3at (25.5W/48V) PoE+ by Intel® I210 with Power On/Off Control, M12 Connector, M12 Connector
LAN 3	GigE IEEE 802.3at (25.5W/48V) PoE+ by Intel® I210 with Power On/Off Control, M12 Connector, M12 Connector
Power	
Input Voltage	6V to 36V, DC-in
Power Interface	3-pin Terminal Block : V+, V-, Frame Ground
Ignition Control	16 Mode (Internal)
Remote Switch	3-pin Terminal Block : On, Off, IGN
Surge Protection	Up to 80V/1ms Transient Power
Others	
TPM	Optional Infineon SLB9665 supports TPM 2.0, LPC interface
Watchdog Timer	Reset : 1 to 255 sec./min. per step
Smart Management	Wake on LAN, PXE supported
HW Monitor	Monitoring temperature, voltages. Auto throttling control when CPU overheats.

Software Support	
OS	Windows 10, Windows 8.1, Windows 7, Linux (Windows 8.1 & 7 are not available for Kaby Lake)
Mechanical	
Dimensions (WxDxH)	186mm x 147mm x 82mm (7.3" x 5.8" x 3.2")
Weight	2.2 kg (4.85 lb)
Mounting	<ul style="list-style-type: none"> • Wallmount by mounting bracket • DIN Rail Mount (Optional)
Environment	
Operating Temperature	-40°C to 75°C (-40°F to 185°F)
Storage Temperature	-40°C to 85°C (-40°F to 185°F)
Humidity	5% to 95% humidity, non-condensing
Relative Humidity	95% at 75°C
Shock	<ul style="list-style-type: none"> • IEC 60068-2-27 • SSD : 50G @ Wallmount, Half-sine, 11ms
Vibration	<ul style="list-style-type: none"> • IEC 60068-2-64 • SSD : 5Grms, 5Hz to 500Hz, 3 Axis
EMC	CE, FCC, EN50155, EN50121-3-2

1.3.4 Specifications of ARS-2001

System	
Processor	Intel® Core™ i7/i5/i3 U-series Processor (Kaby Lake-U/Skylake-U)
Chipset	Intel® SoC
BIOS	AMI
SIO	IT8786E
Memory	<ul style="list-style-type: none"> • DDR4 2133MHz • Up to 64GB • 2 260-pin SO-DIMM Socket
I/O Interface	
Serial	<ul style="list-style-type: none"> • 1 Isolated COM RS-232/422/485 (2.5kV Isolation) • 3 COM RS-232/422/485
USB	4 USB 3.0 (External)
Isolated DIO	32 Isolated DIO (16 DI, 16 DO) , support NPN/PNP
LED	Power, HDD, Wireless, PoE
SIM Card	1 SIM Card Socket (External)

Expansion	
Mini PCIe	2 Mini PCIe Socket : <ul style="list-style-type: none"> • 1 Full-size for PCIe/USB/mSATA • 1 Full-size for PCIe/USB/External SIM Card
PCI/PCIe	1 PCI Slot
Graphics	
Graphics Processor	• Intel® HD Graphics 620/520
Interface	• DVI-I : Up to 1920 x 1200 @ 60Hz • DVI-D : Up to 1920 x 1200 @ 60Hz
Storage	
SATA	2 SATA III (6Gbps) support S/W RAID 0, 1 : <ul style="list-style-type: none"> • 1 SATA III (6Gbps) • 1 SATA III co-lay with Mini PCIe (6Gbps)
mSATA	1 SATA III co-lay with SATA (Mini PCIe Type, 6Gbps)
Storage Device	• 1 CFAST Socket, Push-in/Push-out Ejector • 2 2.5" SSD/HDD Bracket (Internal)
Audio	
Audio Codec	Realtek ALC888S-VD, 7.1 Channel HD Audio
Audio Interface	1 Mic-in, 1 Line-out
Ethernet	
LAN 1	Intel® I219LM GigE LAN supports iAMT 11.0
PoE	
LAN 2	GigE IEEE 802.3at (25.5W/48V) PoE+ by Intel® I210 with Power On/Off Control
LAN 3	GigE IEEE 802.3at (25.5W/48V) PoE+ by Intel® I210 with Power On/Off Control
Power	
Input Voltage	6V to 36V, DC-in
Power Interface	3-pin Terminal Block : V+, V-, Frame Ground
Ignition Control	16 Mode (Internal)
Remote Switch	3-pin Terminal Block : On, Off, IGN
Surge Protection	Up to 80V/1ms Transient Power
Others	
TPM	Optional Infineon SLB9665 supports TPM 2.0, LPC interface
Watchdog Timer	Reset : 1 to 255 sec./min. per step
Smart Management	Wake on LAN, PXE supported
HW Monitor	Monitoring temperature, voltages. Auto throttling control when CPU overheats.

Software Support	
OS	Windows 10, Windows 8.1, Windows 7, Linux (Windows 8.1 & 7 are not available for Kaby Lake)
Mechanical	
Dimensions (WxDxH)	186mm x 147mm x 82mm (7.3" x 5.8" x 3.2")
Weight	2.2 kg (4.85 lb)
Mounting	<ul style="list-style-type: none"> • Wallmount by mounting bracket • DIN Rail Mount (Optional)
Environment	
Operating Temperature	-40°C to 75°C (-40°F to 185°F)
Storage Temperature	-40°C to 85°C (-40°F to 185°F)
Humidity	5% to 95% humidity, non-condensing
Relative Humidity	95% at 75°C
Shock	<ul style="list-style-type: none"> • IEC 60068-2-27 • SSD : 50G @ Wallmount, Half-sine, 11ms
Vibration	<ul style="list-style-type: none"> • IEC 60068-2-64 • SSD : 5Grms, 5Hz to 500Hz, 3 Axis
EMC	CE, FCC, EN50155, EN50121-3-2

1.3.5 Specifications of ARS-2000ML

System	
Processor	Intel® Core™ i7/i5/i3 U-series Processor (Kaby Lake-U/Skylake-U)
Chipset	Intel® SoC
BIOS	AMI
SIO	IT8786E
Memory	<ul style="list-style-type: none"> • DDR4 2133MHz • Up to 64GB • 2 260-pin SO-DIMM Socket
I/O Interface	
Serial	<ul style="list-style-type: none"> • 1 Isolated COM RS-232/422/485 (2.5kV Isolation) • 1 COM RS-232/422/485
USB	4 USB 3.0 (External)
GPIO	16 GPIO (Internal)
LED	Power, HDD, Wireless, PoE
SIM Card	1 SIM Card Socket (External)

Expansion	
Mini PCIe	2 Mini PCIe Socket : <ul style="list-style-type: none"> • 1 Full-size for PCIe/USB/mSATA • 1 Full-size for PCIe/USB/External SIM Card
Graphics	
Graphics Processor	• Intel® HD Graphics 620/520
Interface	• DVI-I : Up to 1920 x 1200 @ 60Hz • DVI-D : Up to 1920 x 1200 @ 60Hz
Storage	
SATA	2 SATA III (6Gbps) support S/W RAID 0, 1 : <ul style="list-style-type: none"> • 1 SATA III (6Gbps) • 1 SATA III co-lay with Mini PCIe (6Gbps)
mSATA	1 SATA III co-lay with SATA (Mini PCIe Type, 6Gbps)
Storage Device	• 1 CFast Socket, Push-in/Push-out Ejector • 2 2.5" SSD/HDD Bracket (Internal)
Audio	
Audio Codec	Realtek ALC888S-VD, 7.1 Channel HD Audio
Audio Interface	1 Mic-in, 1 Line-out
Ethernet	
LAN 1	Intel® I219LM GigE LAN supports iAMT 11.0
PoE	
LAN 2	GigE IEEE 802.3at (25.5W/48V) PoE ⁺ by Intel® I210 with Power On/Off Control, M12 Connector
LAN 3	GigE IEEE 802.3at (25.5W/48V) PoE ⁺ by Intel® I210 with Power On/Off Control, M12 Connector
Power	
Input Voltage	6V to 36V, DC-in
Power Interface	3-pin Terminal Block : V+, V-, Frame Ground
Ignition Control	16 Mode (Internal)
Remote Switch	3-pin Terminal Block : On, Off, IGN
Surge Protection	Up to 80V/1ms Transient Power
Others	
TPM	Optional Infineon SLB9665 supports TPM 2.0, LPC interface
Watchdog Timer	Reset : 1 to 255 sec./min. per step
Smart Management	Wake on LAN, PXE supported
HW Monitor	Monitoring temperature, voltages. Auto throttling control when CPU overheats.

Software Support	
OS	Windows 10, Windows 8.1, Windows 7, Linux (Windows 8.1 & 7 are not available for Kaby Lake)
Mechanical	
Dimensions (WxDxH)	186mm x 147mm x 54mm (7.3" x 5.8" x 2.1")
Weight	1.8 kg (3.97 lb)
Mounting	<ul style="list-style-type: none"> • Wallmount by mounting bracket • DIN Rail Mount (Optional)
Environment	
Operating Temperature	-40°C to 70°C (-40°F to 158°F)
Storage Temperature	-40°C to 85°C (-40°F to 185°F)
Humidity	5% to 95% humidity, non-condensing
Relative Humidity	95% at 70°C
Shock	<ul style="list-style-type: none"> • IEC 60068-2-27 • SSD : 50G @ Wallmount, Half-sine, 11ms
Vibration	<ul style="list-style-type: none"> • IEC 60068-2-64 • SSD : 5Grms, 5Hz to 500Hz, 3 Axis
EMC	CE, FCC, EN50155, EN50121-3-2

1.3.6 Specifications of ARS-2000L

System	
Processor	Intel® Core™ i7/i5/i3 U-series Processor (Kaby Lake-U/Skylake-U)
Chipset	Intel® SoC
BIOS	AMI
SIO	IT8786E
Memory	<ul style="list-style-type: none"> • DDR4 2133MHz • Up to 64GB • 2 260-pin SO-DIMM Socket
I/O Interface	
Serial	<ul style="list-style-type: none"> • 1 Isolated COM RS-232/422/485 (2.5kV Isolation) • 1 COM RS-232/422/485
USB	4 USB 3.0 (External)
GPIO	16 GPIO (Internal)
LED	Power, HDD, Wireless, PoE
SIM Card	1 SIM Card Socket (External)

Expansion	
Mini PCIe	2 Mini PCIe Socket : <ul style="list-style-type: none"> • 1 Full-size for PCIe/USB/mSATA • 1 Full-size for PCIe/USB/External SIM Card
Graphics	
Graphics Processor	• Intel® HD Graphics 620/520
Interface	• DVI-I : Up to 1920 x 1200 @ 60Hz • DVI-D : Up to 1920 x 1200 @ 60Hz
Storage	
SATA	2 SATA III (6Gbps) support S/W RAID 0, 1 : <ul style="list-style-type: none"> • 1 SATA III (6Gbps) • 1 SATA III co-lay with Mini PCIe (6Gbps)
mSATA	1 SATA III co-lay with SATA (Mini PCIe Type, 6Gbps)
Storage Device	• 1 CFast Socket, Push-in/Push-out Ejector • 2 2.5" SSD/HDD Bracket (Internal)
Audio	
Audio Codec	Realtek ALC888S-VD, 7.1 Channel HD Audio
Audio Interface	1 Mic-in, 1 Line-out
Ethernet	
LAN 1	Intel® I219LM GigE LAN supports iAMT 11.0
PoE	
LAN 2	GigE IEEE 802.3at (25.5W/48V) PoE+ by Intel® I210 with Power On/Off Control
LAN 3	GigE IEEE 802.3at (25.5W/48V) PoE+ by Intel® I210 with Power On/Off Control
Power	
Input Voltage	6V to 36V, DC-in
Power Interface	3-pin Terminal Block : V+, V-, Frame Ground
Ignition Control	16 Mode (Internal)
Remote Switch	3-pin Terminal Block : On, Off, IGN
Surge Protection	Up to 80V/1ms Transient Power
Others	
TPM	Optional Infineon SLB9665 supports TPM 2.0, LPC interface
Watchdog Timer	Reset : 1 to 255 sec./min. per step
Smart Management	Wake on LAN, PXE supported
HW Monitor	Monitoring temperature, voltages. Auto throttling control when CPU overheats.

Software Support	
OS	Windows 10, Windows 8.1, Windows 7, Linux (Windows 8.1 & 7 are not available for Kaby Lake)
Mechanical	
Dimensions (WxDxH)	186mm x 147mm x 54mm (7.3" x 5.8" x 2.1")
Weight	1.8 kg (3.97 lb)
Mounting	<ul style="list-style-type: none"> • Wallmount by mounting bracket • DIN Rail Mount (Optional)
Environment	
Operating Temperature	-40°C to 70°C (-40°F to 158°F)
Storage Temperature	-40°C to 85°C (-40°F to 185°F)
Humidity	5% to 95% humidity, non-condensing
Relative Humidity	95% at 70°C
Shock	<ul style="list-style-type: none"> • IEC 60068-2-27 • SSD : 50G @ Wallmount, Half-sine, 11ms
Vibration	<ul style="list-style-type: none"> • IEC 60068-2-64 • SSD : 5Grms, 5Hz to 500Hz, 3 Axis
EMC	CE, FCC, EN50155, EN50121-3-2

1.4 Supported CPU List

Processor No.	TDP	Cache	Max. Frequency	Embedded
i7-7600U	15W	4M	Up to 3.9 GHz	Yes
i7-6600U	15W	4M	Up to 3.4 GHz	Yes
i5-6300U	15W	4M	Up to 3.0 GHz	Yes
i3-6100U	15W	4M	Up to 2.30 GHz	Yes
Celeron 3955U	15W	2M	Up to 2.00 GHz	Yes

1.5 Mechanical Dimension

1.5.1 Dimensions of ARS-2010M/2001M

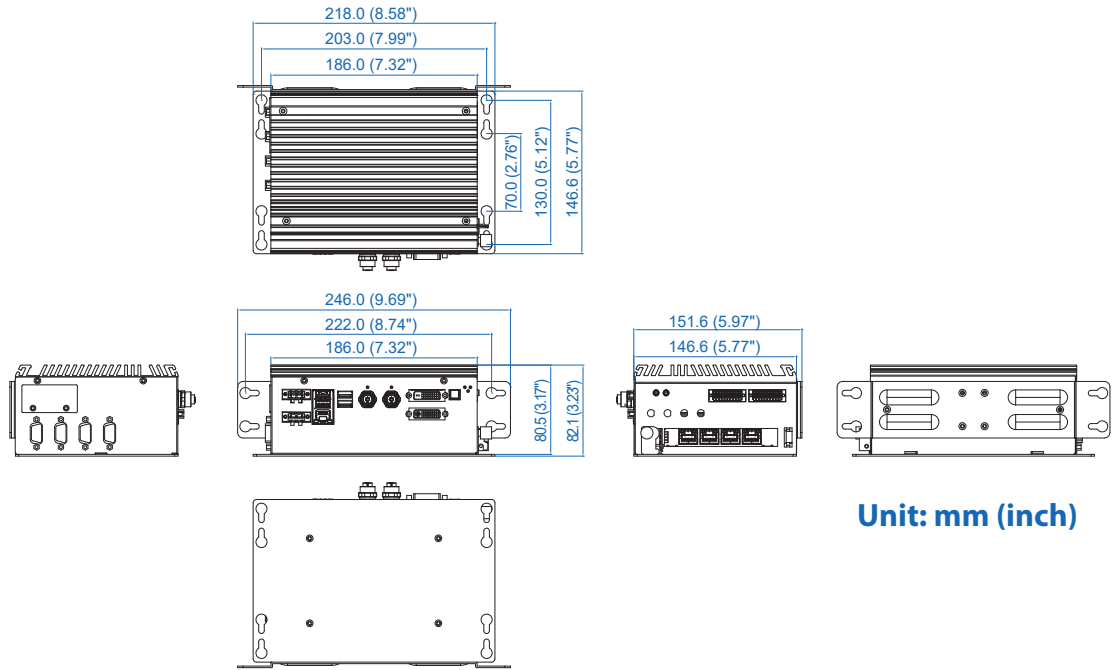

1.5.2 Dimensions of ARS-2010/2001

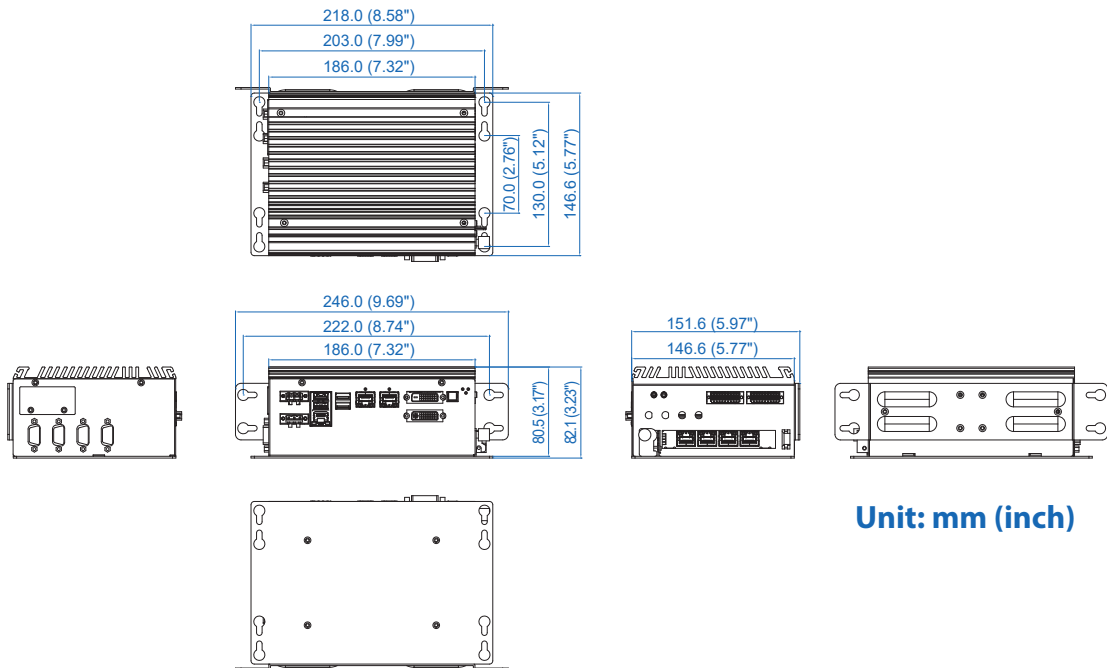

1.5.3 Dimensions of ARS-2000ML

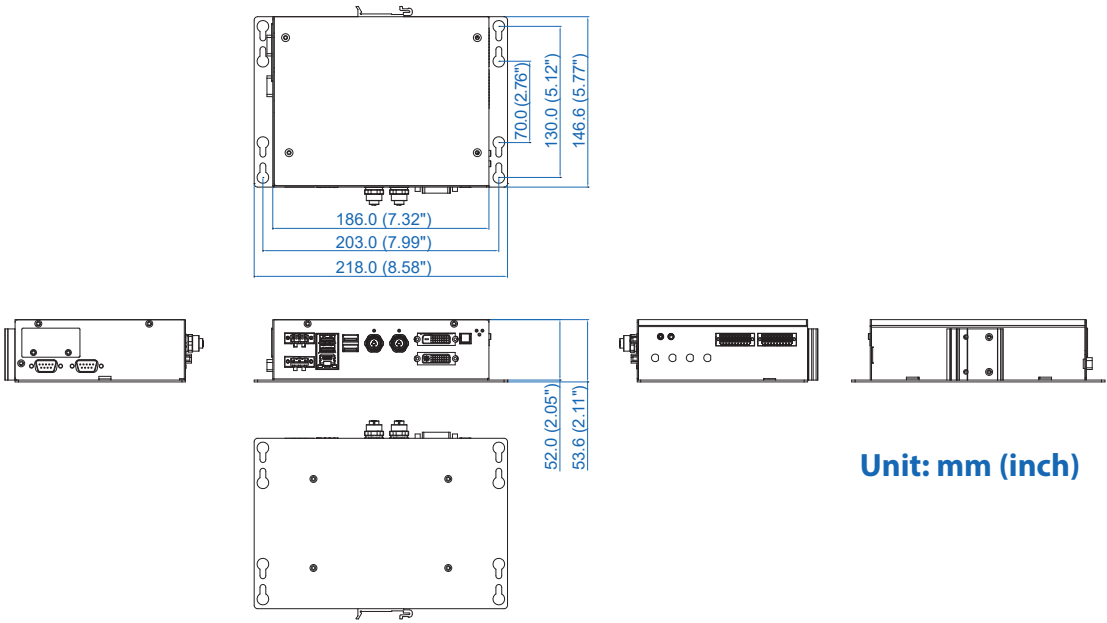

1.5.4 Dimensions of ARS-2000L

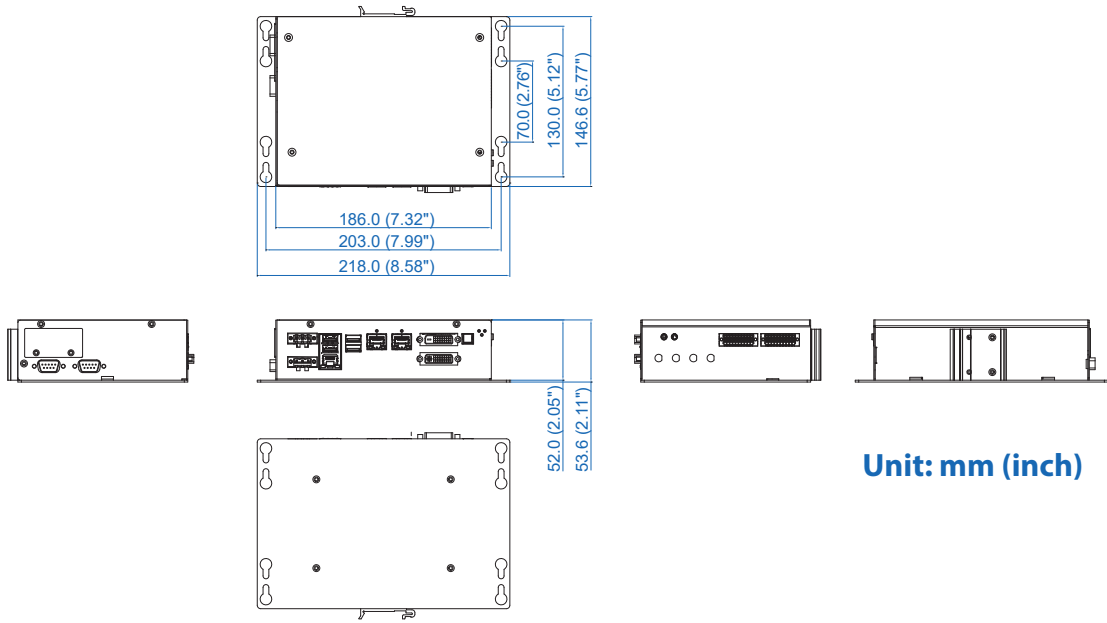

2

GETTING TO KNOW YOUR ARS-2000

2.1 Packing List

Item	Description	Qty
1	ARS-2000 Fanless Compact Embedded Box PC (According to the configuration of you order, ARS-2000 series may contain SSD/HDD and DDR4 SO-DIMM. Please verify these items if necessary.)	1
2	ARS-2000 series accessory box, which contains <ul style="list-style-type: none">● Wall-mounting bracket● PH-M4x16.5-S-Ni● M2.5x6 screw for Mini PCIe Slot● F-M3x4 screws for wall mount bracket● KH-M3x6L Ni for SSD/HDD Bracket● Foot Pad● SATA cable● 3-pin pluggable terminal block● 20-pin pluggable terminal block	1 4 2 4 8 4 1 2 2

2.2 Front Panel I/O & Functions

In Vecow ARS-2000 series, it has 3-side of the I/O connectors which located on front, top and bottom panels. Most of the general connections to computer device, such as USB, DVI, LAN Jack and PoE ports, are placed on the front panel.

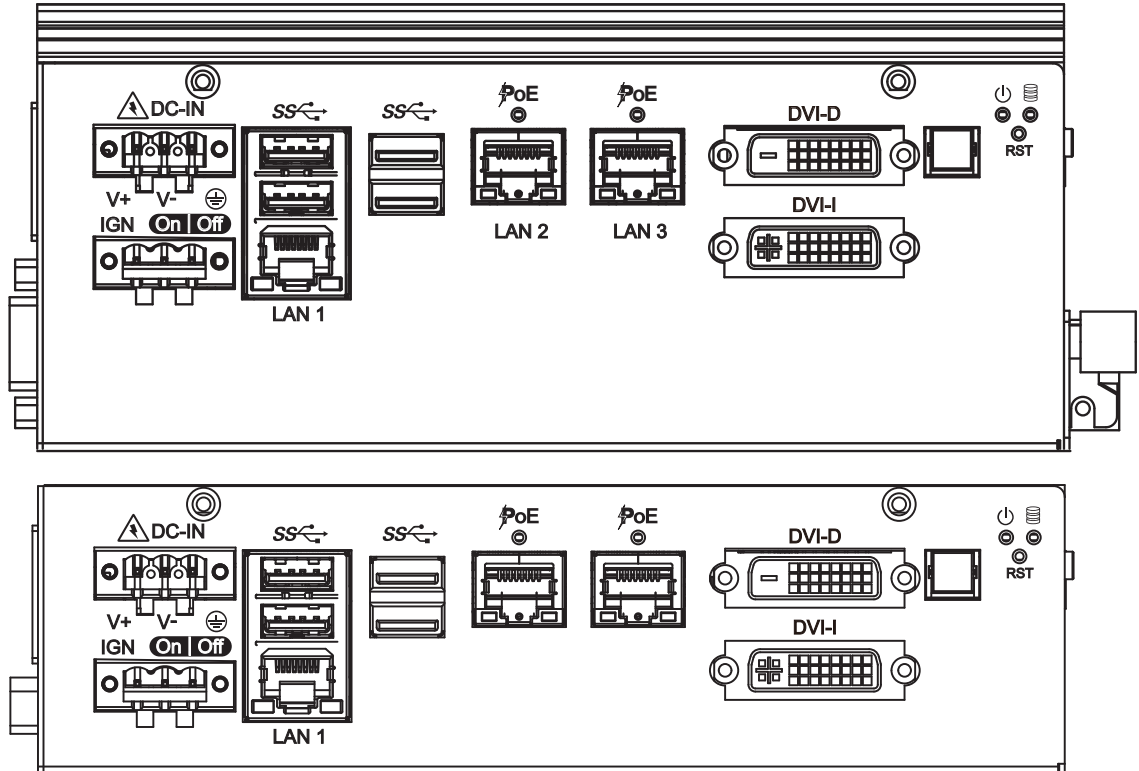

2.2.1 Reset Tact Switch

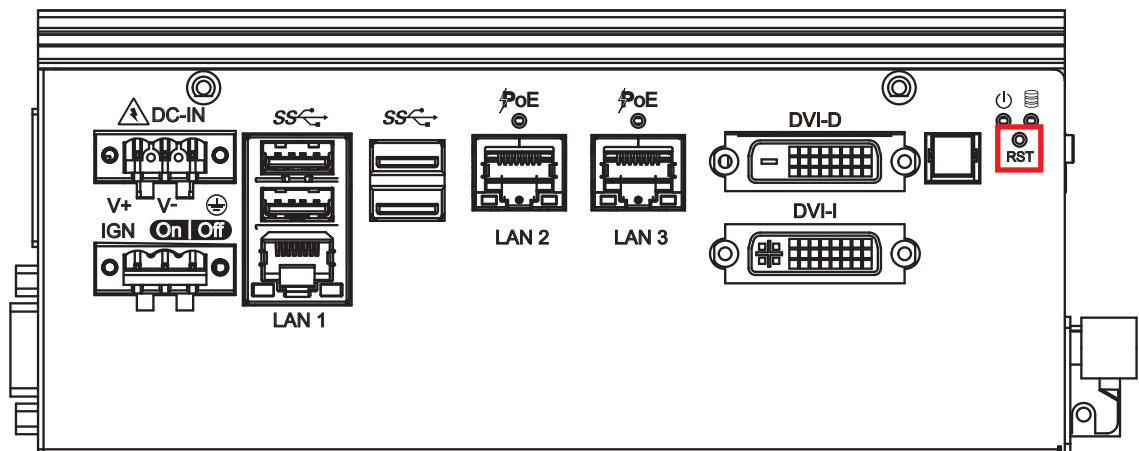

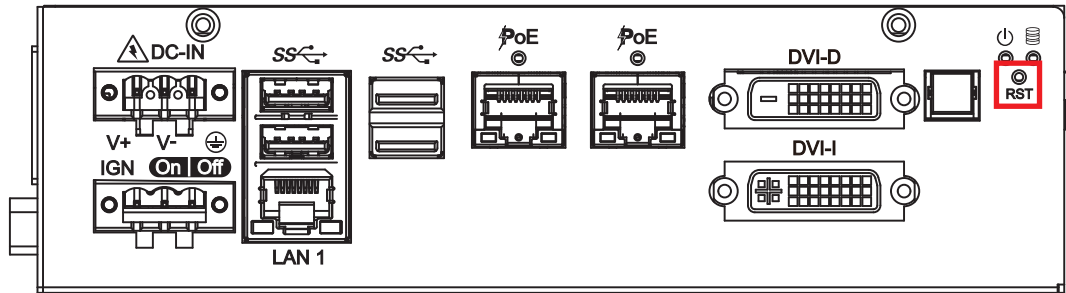

It is a hardware reset switch. Please use this switch to reset ARS-2000 without power off. Press the Reset Switch for a few seconds, and then reset will be enabled.

2.2.2 PWR & HDD LED Indicator

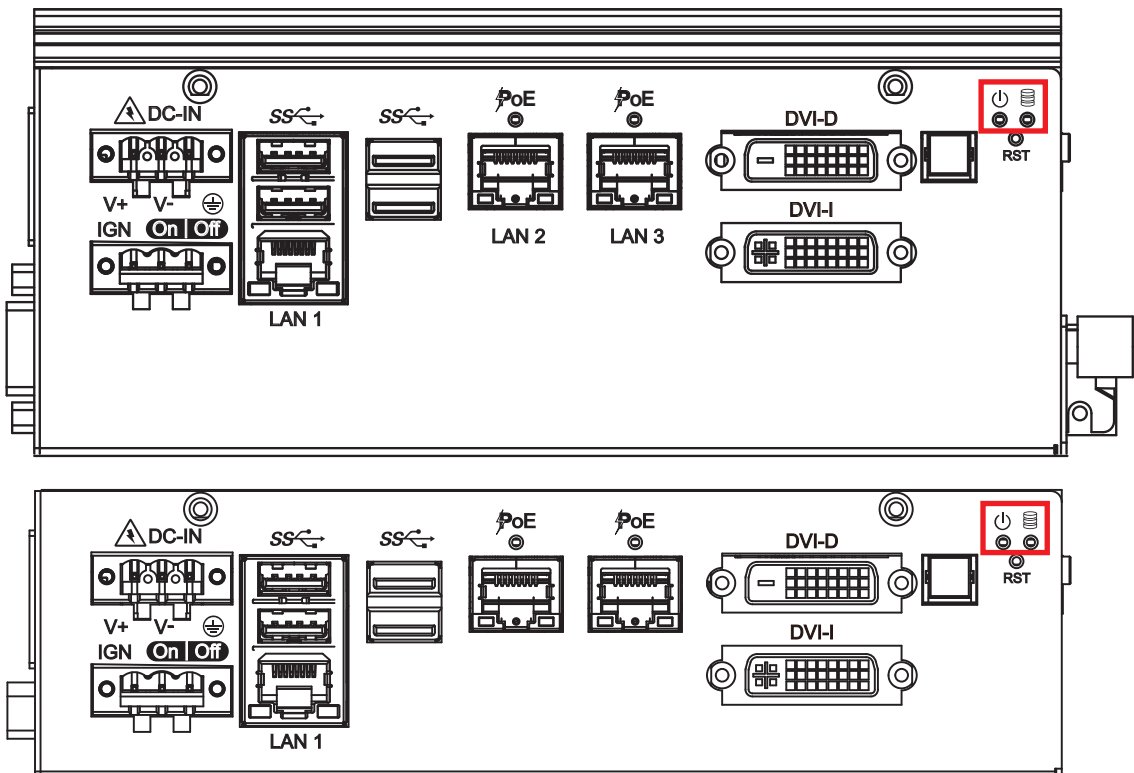

HDD LED/Yellow : A hard disk/CFast LED. If the LED is on, it indicates that ARS-2000 storage is functional. If it is off, it indicates that the system's storage is not functional. If it is flashing, it indicates data access activities.

Power LED/Green : If the LED is solid green, it indicates that the system is powered on.

LED Color	Power Status	System Status
Yellow	HDD/CFast	<ul style="list-style-type: none"> On/Off : Storage status, function or not. Twinkling : Data transferring.
Green	Power	System power status (on/off)

2.2.3 Power Button

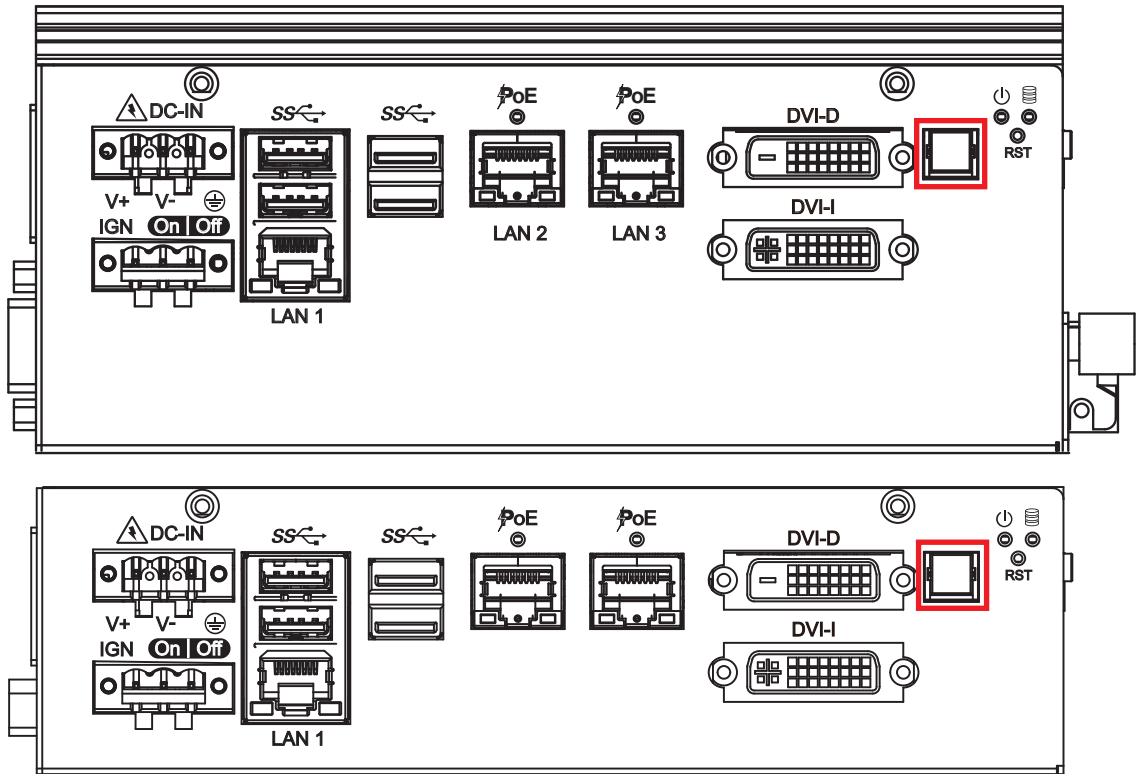

The Power Button is a non-latched switch with dual color LED indications. It indicates power status: S0, S3 and S5. More detail LED indications are listed as follows:

LED Color	Power Status	System Status
Solid Blue	S0	System working
Solid Orange	S3, S5	Suspend to RAM, System off with standby power

To power on ARS-2000, please press the power button and then the blue LED is lightened. To power off the system, you can either command shutdown by OS operation, or just simply press the power button.

If system error, you can just press the power button for 4-seconds to shut down the machine directly. Please do note that a 4-second interval between each 2 power-on/power-off operation is necessary in normal working status. (For example, once turning off the system, you have to wait for 4 seconds to initiate another power-on operation.)

2.2.4 Power Terminal Block

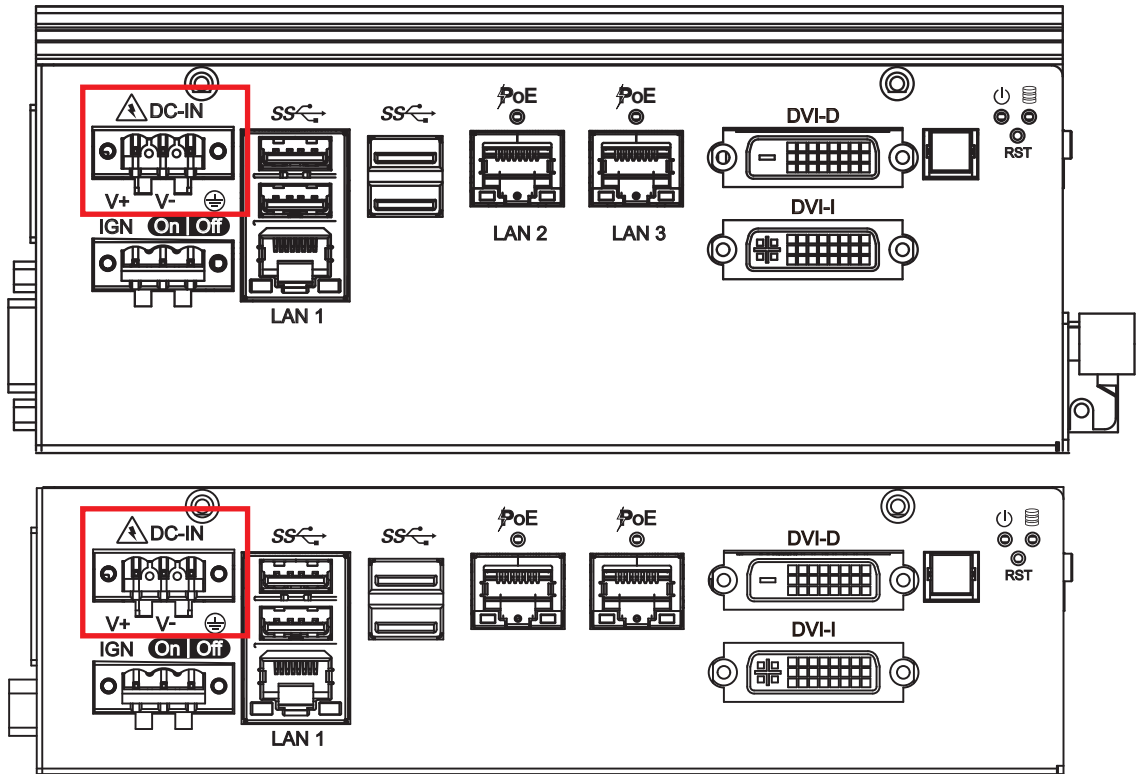

ARS-2000 supports 6V to 36V DC power input by terminal block on the front side. In normal power operation, power LED lightens in solid green. (Onboard LTC4356 supports up to 80V surge protection.)

Pin No.	Definition	Pin No.	Definition
1	V+	2	V-
3	Chassis Ground		

2.2.5 Remote Power On/Off Switch & Ignition

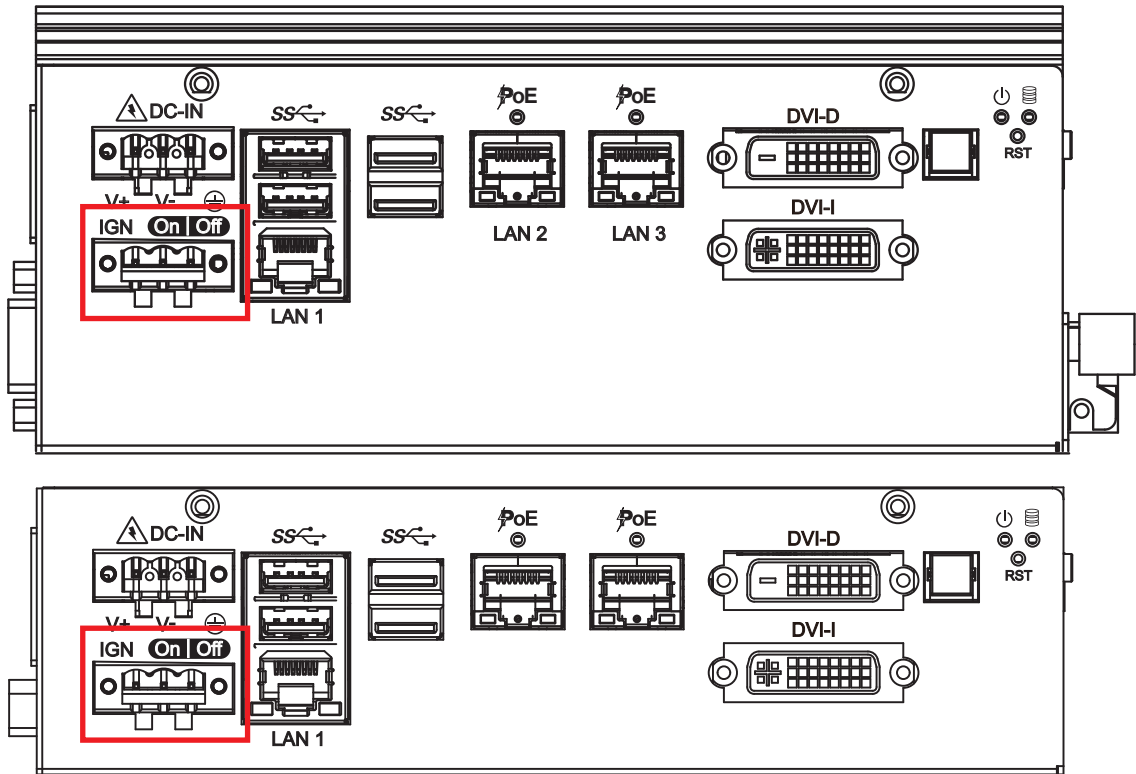

It is a 2-pin power-on or power-off switch through Phoenix Contact terminal block. You could turn on or off the system power by using this contact. This terminal block supports dual function of soft power-on/power-off (instant off or delay 4 second), and suspending modes.

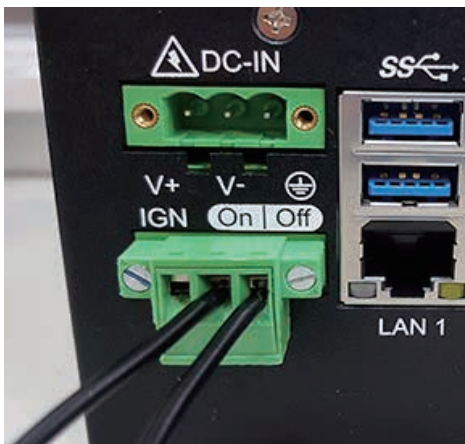

Pin No.	Definition
1	Ignition (IGN)
2	S/W +
3	S/W -



2.2.6 DVI-D Connector

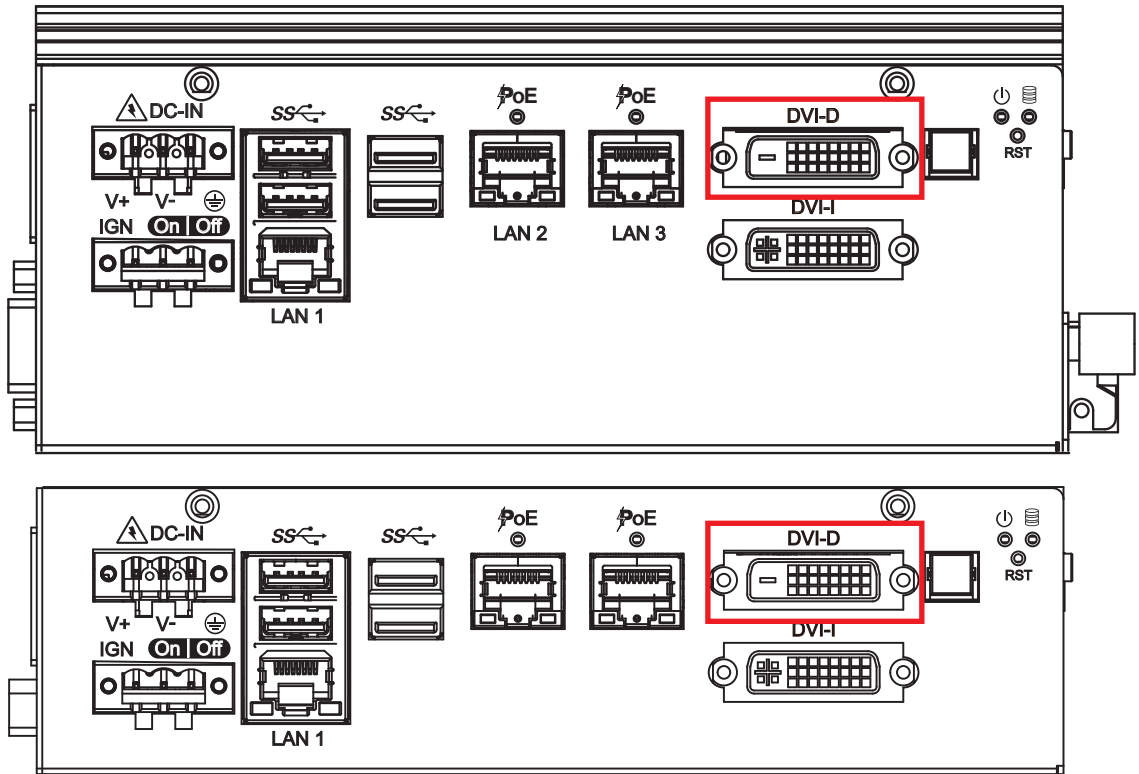

The DVI-D connector on the front panel supports DVI display. This connector can output DVI signal. The DVI output mode supports up to 1920 x 1200 resolution. The DVI is automatically selected according to the connected display. You will need a DVI-D cable when connecting to a display device.

2.2.7 DVI-I Connector

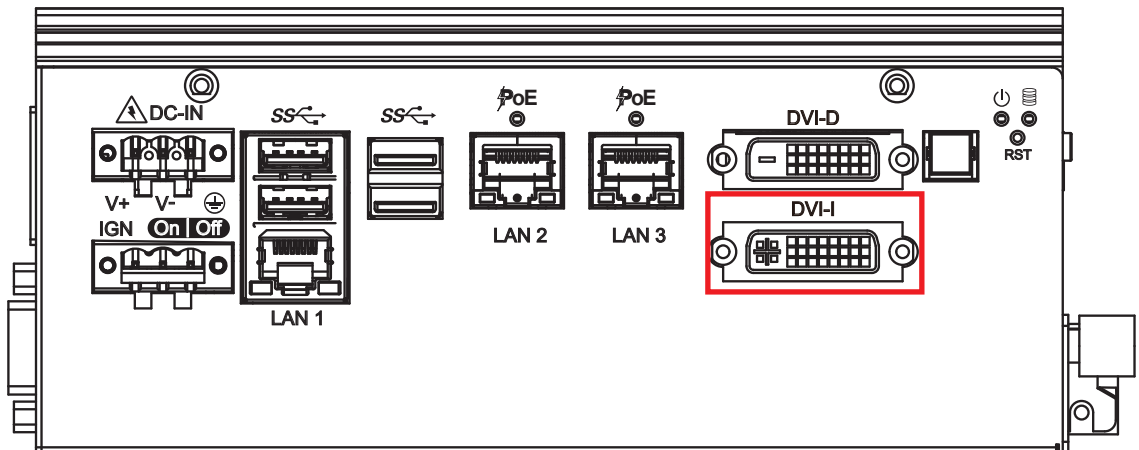

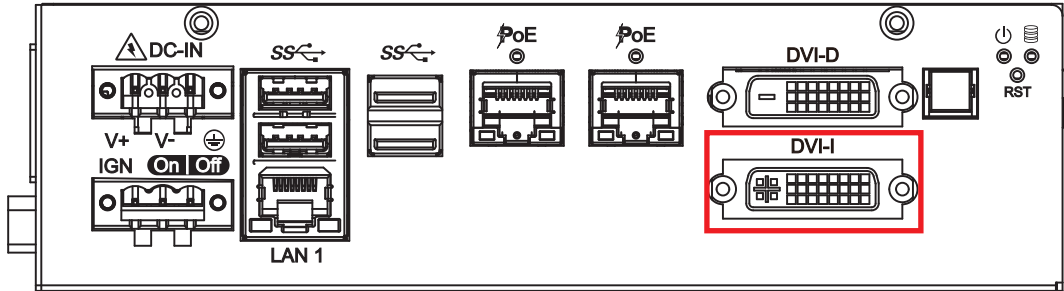

The DVI-I connector on the front panel supports both DVI and VGA display modes. This connector can output DVI signals. The DVI output mode supports up to 1920 x 1200 resolution. The DVI mode is automatically selected according to the connected display and you will need a DVI-I cable when connecting to a display device. The VGA output mode also supports up to 1920 x 1200 resolution. If using VGA function, you will need a DVI-I to VGA dongle connected to DVI-I device. Below is the DVI-I to VGA dongle image :



2.2.8 USB 3.0

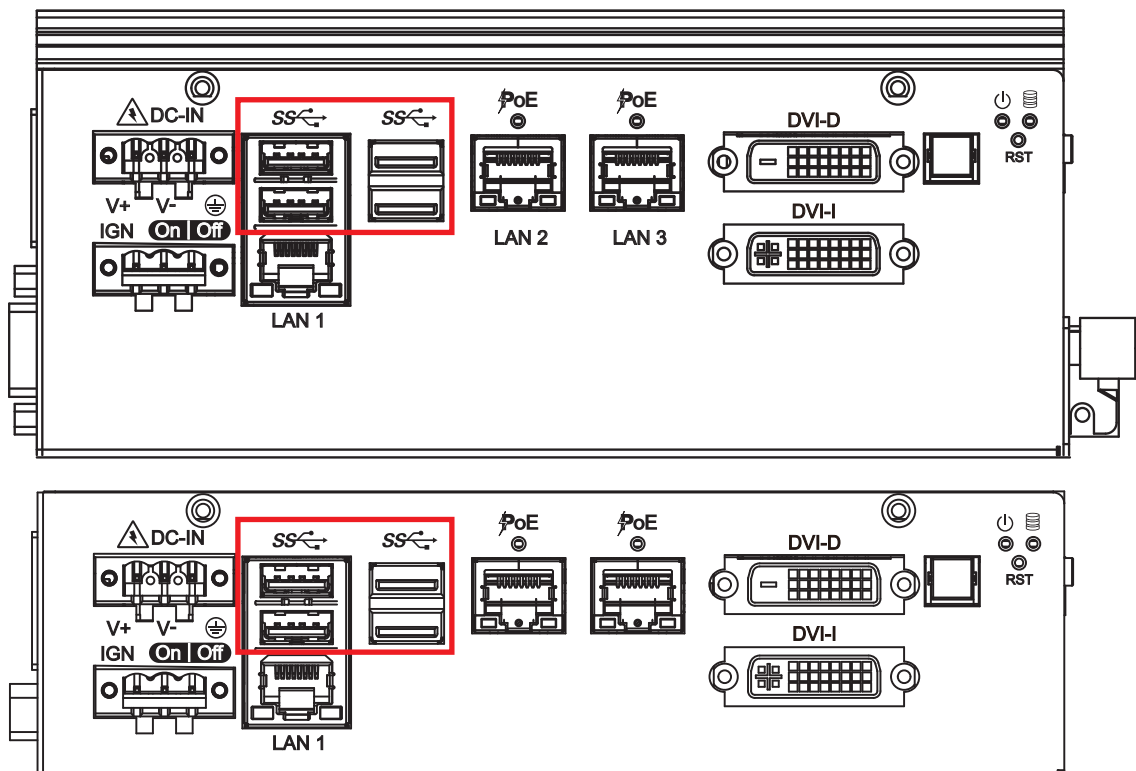

There are 4 USB 3.0 connections available supporting up to 5GB per second data rate in the front side of ARS-2000. It is also compliant with the requirements of Super Speed (SS), High Speed (HS), Full Speed (FS) and Low Speed (LS).

2.2.9 Ethernet Port

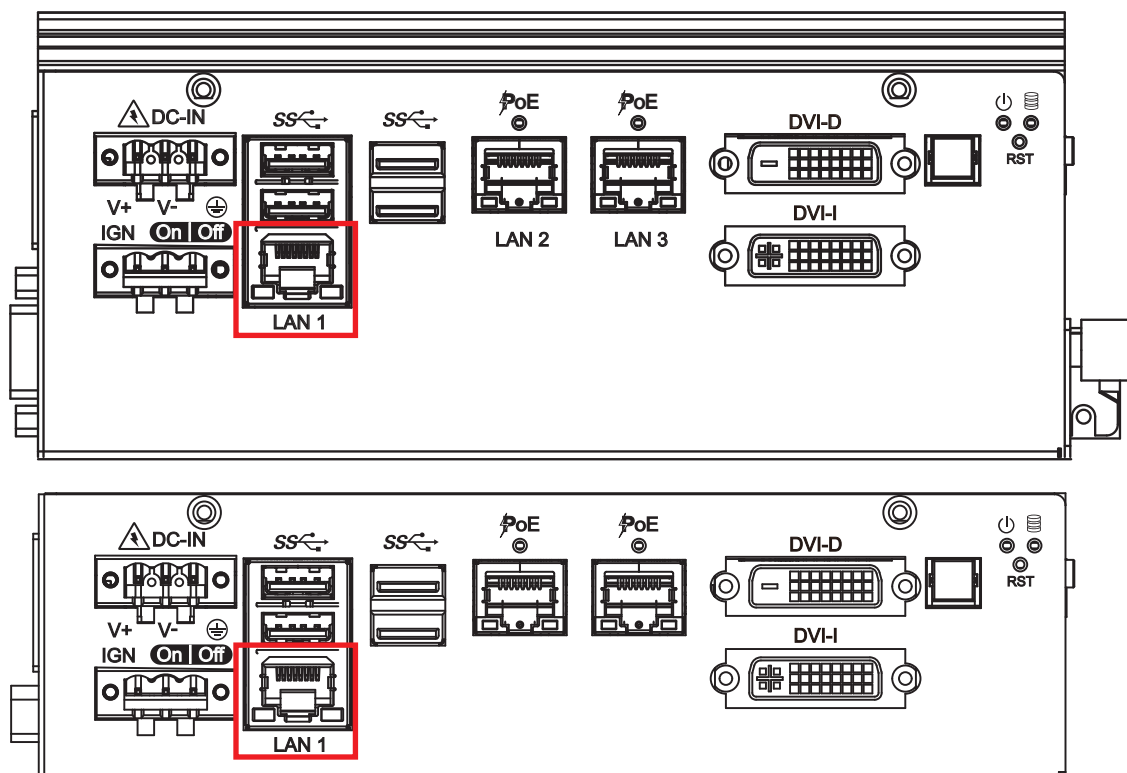

There is one 8-pin RJ-45 jacks supporting 10/100/1000 Mbps Ethernet connections on the front side. LAN 1 is powered by Intel I219 Ethernet Phy. When LAN 1 works at normal status, iAMT 11.0 function is enabled.

Using suitable RJ-45 cable, you can connect the system to a computer or to any other devices with Ethernet connection; for example, a hub or a switch. Moreover, LAN 1 supports Wake on LAN and Pre-boot functions. The pin-outs of LAN 1 is listed as follows :

Pin No.	10/ 100Mbps	1000Mbps	Pin No.	10/ 100Mbps	1000Mbps
1	E_TX+	MDI0_P	5	----	MDI2_N
2	E_TX-	MDI0_N	6	E_RX-	MDI1_N
3	E_RX+	MDI1_P	7	----	MDI3_P
4	----	MDI2_P	8	-----	MDI3_N

LAN 1 port is supported by standard RJ-45 connector with LED indicators to present Active/Link/Speed status of the connection. The LED indicator on the right bottom corner lightens in solid green when the cable is properly connected to a 100 Mbps Ethernet network. The LED indicator on the right bottom corner lightens in solid orange when the cable is properly connected to a 1000Mbps Ethernet network. The left LED will keep twinkling/off when Ethernet data packets are being transmitted/received.

	10Mbps	100Mbps	1000Mbps
Right Bottom LED	Off	Solid Green	Solid Orange
Left Bottom LED	Flash Orange	Flash Orange	Flash Orange

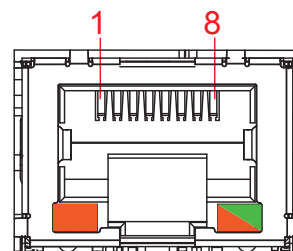

2.2.10 PoE (Power over Ethernet) Ports

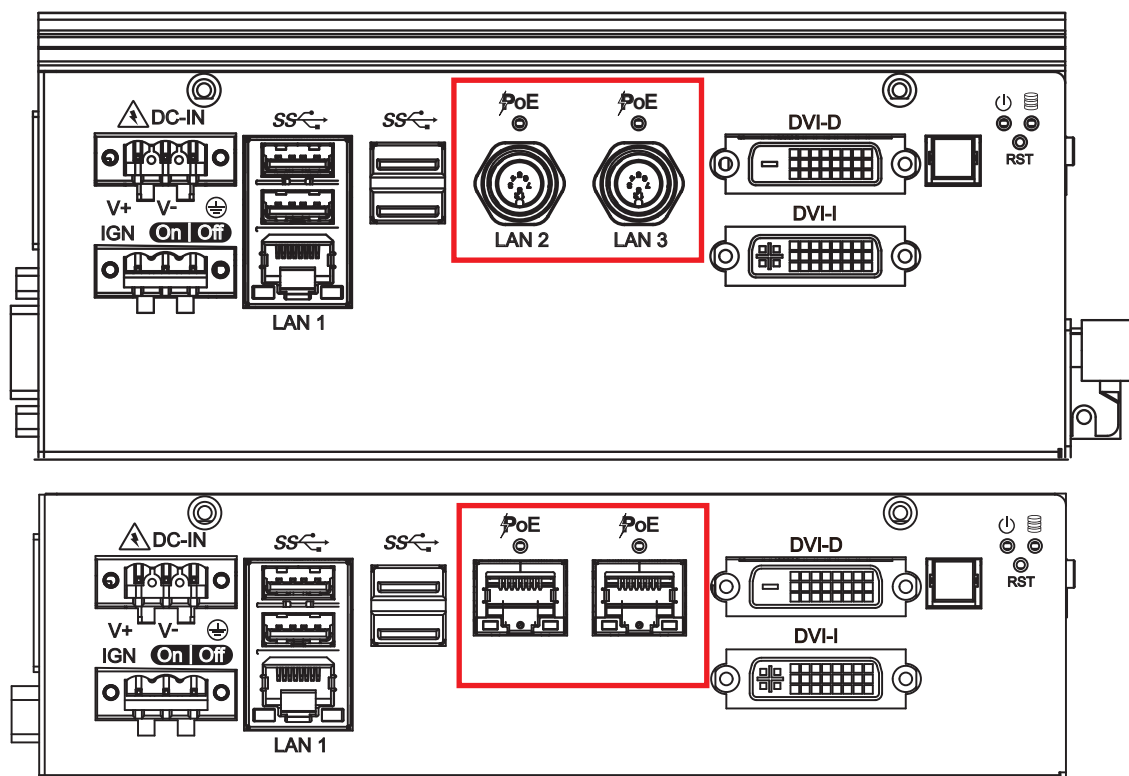

There are 2 RJ45 connectors or 2 M12 connectors on the front side of ARS-2000. It supports IEEE 802.3at (PoE+) Power over Ethernet (PoE) connection delivering up to 37W/54V per port and 1000BASE-T GigE data signals over standard Ethernet Cat 5/Cat 6 cable. Each PoE connection is powered by Intel® i210 GigE Ethernet controller and independent PCI express interface to connect with multi-core processor for network and data transmit optimization. Only when PoE port starts to supply power to power devices, the dedicated LED will be lightened.

PS. Suggest to use PoE function when power input is over 12V.

RJ-45 LAN2 LAN3 Pin Out :

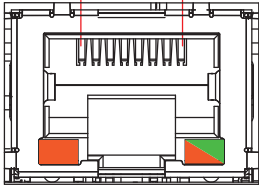
	Pin No.	10/100 Mbps	1 Gbps	POE Signal
	1	E_TX+	MDI0_P	POE +
	2	E_TX-	MDI0_N	POE +
	3	E_RX+	MDI1_P	POE -
	4	----	MDI2_P	----
	5	----	MDI2_N	----
	6	E_RX-	MDI1_N	POE -
	7	----	MDI3_P	----
	8	----	MDI3_N	----

M12 LAN2 LAN3 Pin Out :

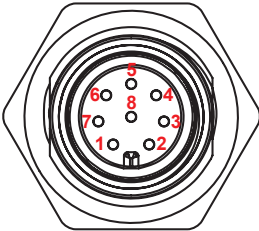
	Pin No.	10/100 Mbps	1 Gbps	POE Signal
	1	----	MDI2_P	----
	2	----	MDI3_P	----
	3	----	MDI3_N	----
	4	E_TX-	MDI0_N	POE +
	5	E_RX+	MDI1_P	POE -
	6	E_TX+	MDI0_P	POE +
	7	----	MDI2_N	----
	8	E_RX-	MDI1_N	POE -

Each LAN port is supported by standard RJ-45 connector with LED indicators to present Active/Link/Speed status of the connection & PoE status LED. The LED indicator on the right bottom corner lightens in solid green when the cable is properly connected to a 100 Mbps Ethernet network. The LED indicator on the right bottom corner lightens in solid orange when the cable is properly connected to a 1000Mbps Ethernet network. The left LED will keep twinkling/off when Ethernet data packets are being transmitted/received.

	10Mbps	100Mbps	1000Mbps
Right Bottom LED	Off	Solid Green	Solid Orange
Left Bottom LED	Flash Orange	Flash Orange	Flash Orange

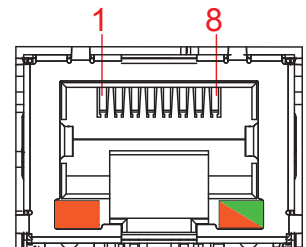

PoE LED indicator

POE LED	LED Color	POE Status
POE	Solid Green	POE ON

2.3 Top Panel I/O & Functions

2.3.1 Isolated DIO (STANDARD) / GPIO (LIGHT)

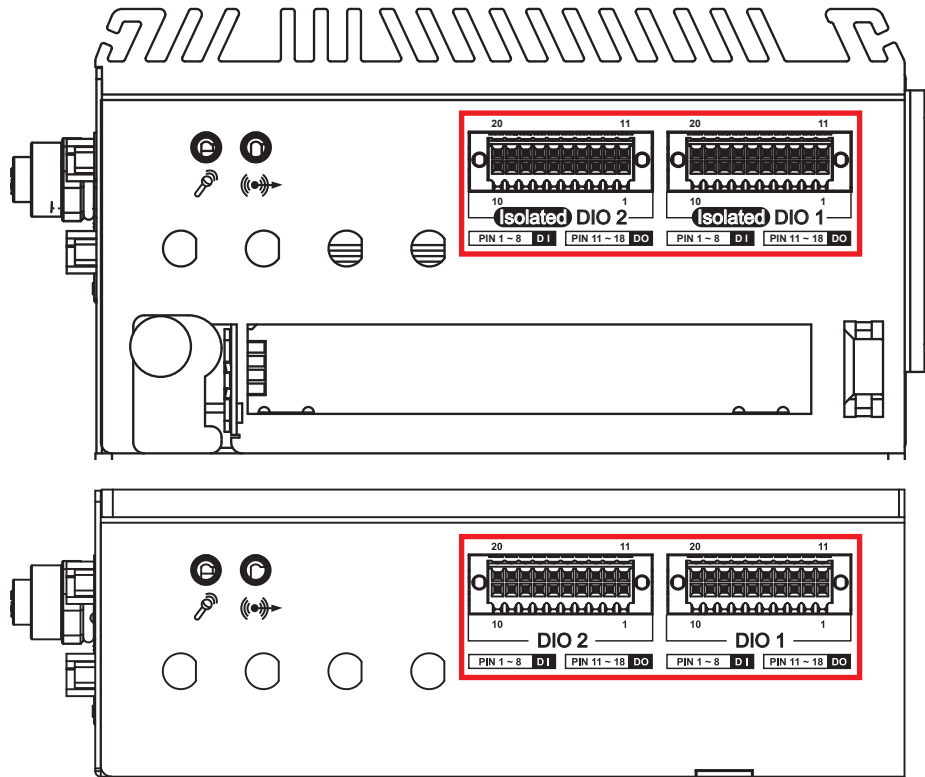

There is a 32-bit (16-bit DI, 16-bit DO) with 2 DIO connectors on the rear side. DI/DIO supports NPN(sink) and PNP(Source) modes, and each DI channel is equipped with a photocoupler for isolated protection. Each DO with isolator chip is configured by a Jumper for each DIO connector.

DO Safety-Related Certifications:

- 4242-VPK Basic Isolation per DIN V VDE V 0884-10 and DIN EN 61010-1
- 3-KVRMS Isolation for 1 minute per UL 1577
- CSA Component Acceptance Notice 5A, IEC 60950-1 and IEC 61010-1 End Equipment Standards
- GB4943.1-2011 CQC Certified

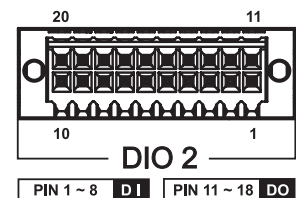
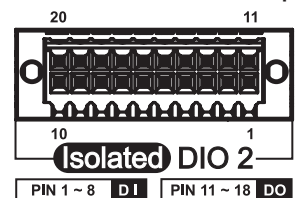

DIO Connectors pin out:

DIO	Pin No.	Definition	Function
DIO1	1	INPUT 0	SIO_GPI80
	2	INPUT 1	SIO_GPI81
	3	INPUT 2	SIO_GPI82
	4	INPUT 3	SIO_GPI83
	5	INPUT 4	SIO_GPI84
	6	INPUT 5	SIO_GPI85

DIO	Pin No.	Definition	Function
	7	INPUT 6	SIO_GPI86
	8	INPUT 7	SIO_GPI87
	9	DI1_COM	-
	10	DIO1_GND	-
	11	OUTPUT 0	SIO_GPO70
	12	OUTPUT 1	SIO_GPO71
	13	OUTPUT 2	SIO_GPO72
	14	OUTPUT 3	SIO_GPO73
	15	OUTPUT 4	SIO_GPO74
	16	OUTPUT 5	SIO_GPO75
	17	OUTPUT 6	SIO_GPO76
	18	OUTPUT 7	SIO_GPO77
	19	DIO1_GND	-
	20	DIO1_VDC (6~48V Input)	-

DIO	Pin No.	Definition	Function
DIO2	1	INPUT 8	SIO_GPI37
	2	INPUT 9	SIO_GPI50
	3	INPUT 10	SIO_GPI51
	4	INPUT 11	SIO_GPI52
	5	INPUT 12	SIO_GPI56
	6	INPUT 13	SIO_GPI57
	7	INPUT 14	SIO_GPI64
	8	INPUT 15	SIO_GPI65
	9	DI2_COM	-
	10	DIO2_GND	-
	11	OUTPUT 8	SIO_GPO11
	12	OUTPUT 9	SIO_GPO12
	13	OUTPUT 10	SIO_GPO15
	14	OUTPUT 11	SIO_GPO16
	15	OUTPUT 12	SIO_GPO32
	16	OUTPUT 13	SIO_GPO33
	17	OUTPUT 14	SIO_GPO35
	18	OUTPUT 15	SIO_GPO36
	19	DIO2_GND	-
	20	DIO2_VDC (6~48V Input)	-

DI reference circuit:

Sink Mode (NPN)

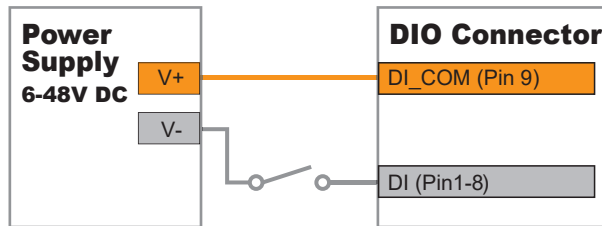

Source Mode (PNP)

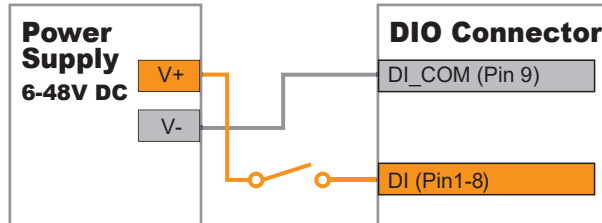

DO reference circuit:

Sink Mode
(NPN, Default)

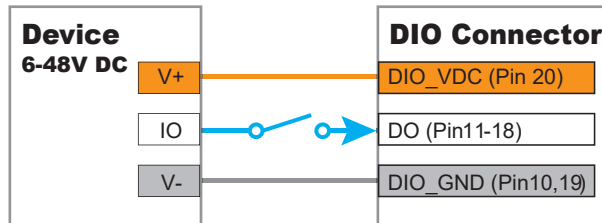

Source Mode
(PNP)

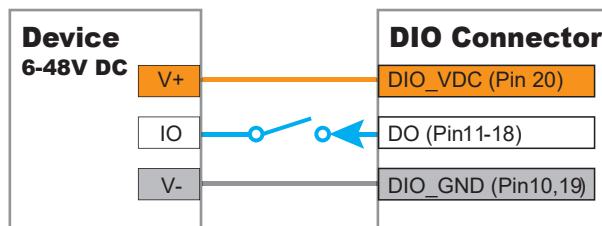

2.3.2 Audio Jack

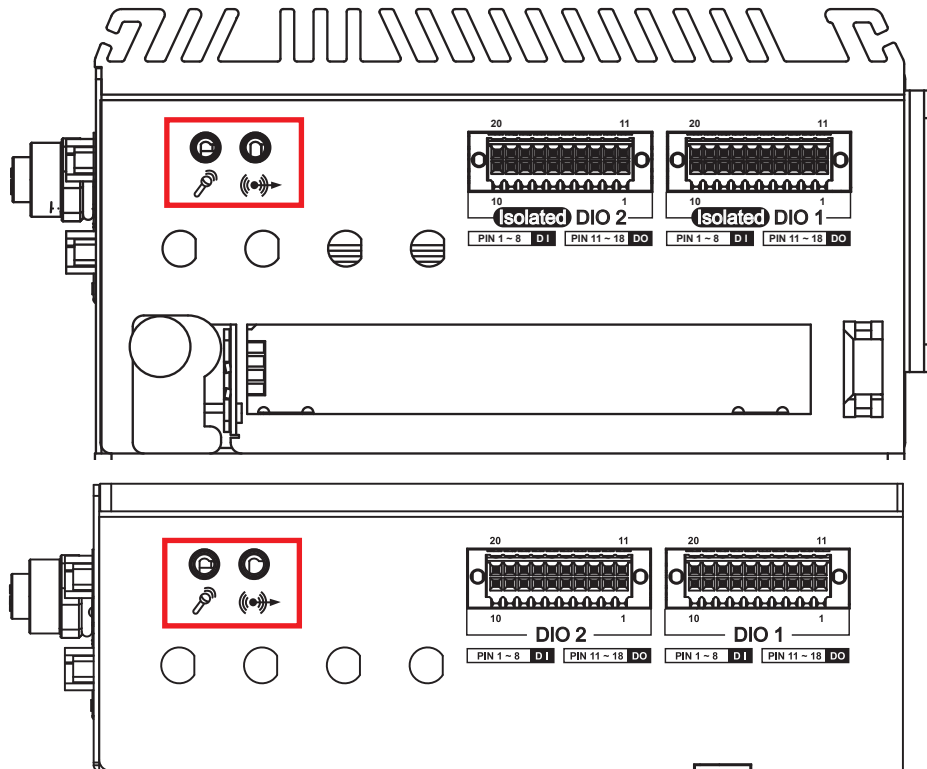

There are 2 audio connectors, Mic-in and Line-out, on the top side of ARS-2000. Onboard Realtek ALC888S-VD audio codec supports 7.1 channel HD audio and fully complies with Intel® High Definition Audio (Azalia) specifications.

To utilize the audio function in Windows platform, you need to install the corresponding drivers for both Intel CM236 chipset and Realtek ALC888S-VD codec.

2.3.3 Add-on Card (NOT for LIGHT version)

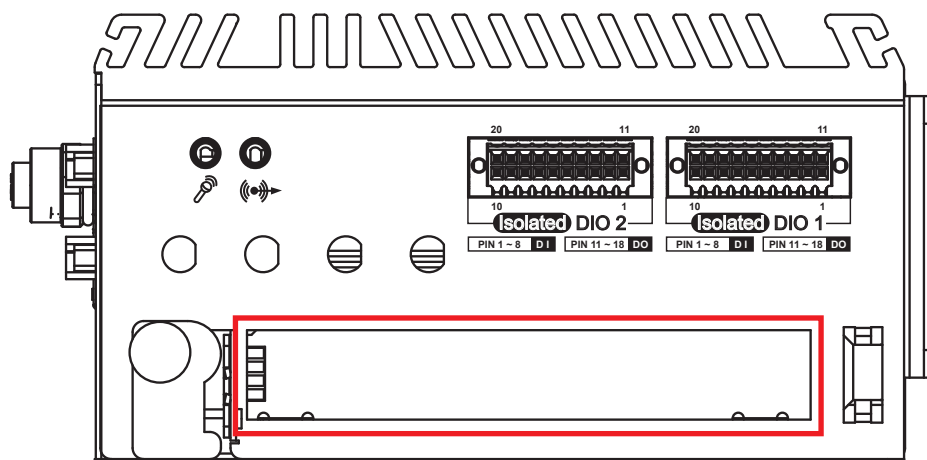

Optional for PCIe x16 slot for x4 signal FHHL add on card or PCI card.

2.4 Bottom Panel I/O & Functions

2.4.1 COM Ports (Isolated COM)

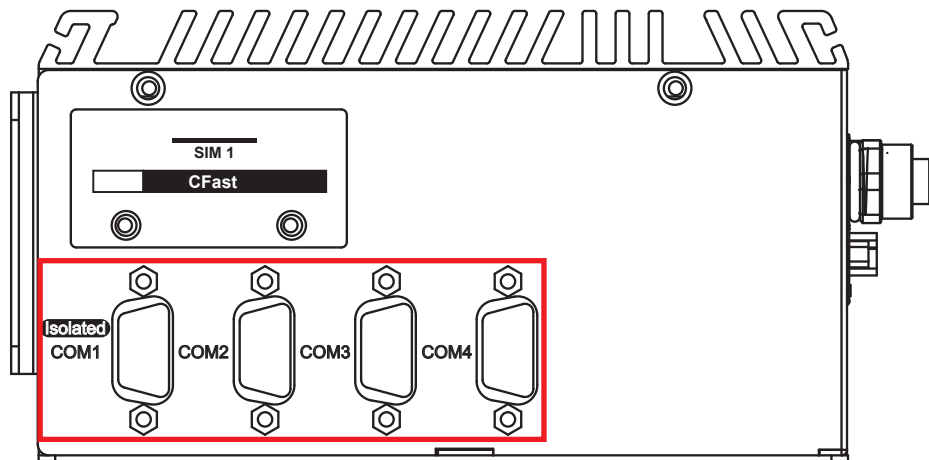

Serial port 1 to 4 (Light version: COM 1 to 2) can be configured for RS-232, RS-422, or RS-485 with auto flow control communication. One of these COM ports, COM 1 supports isolated function and with 2.5-KVRMS Isolation. The default definition of COM 1 to COM 4 (Light version: COM 1 to 2) is RS-232; but if you want to change to RS-422 or RS-485, you can find the setting in BIOS.

BIOS Setting	Function
COM 1	RS-232
COM 2	RS-422 (5-wire)
	RS-422 (9-wire)
COM 3	RS-485
COM 4	RS-485 w/ auto-flow control

The pin assignments are listed in the table as below:

Serial Port	Pin No.	RS-232	RS-422 (5-wire)	RS-422 (9-wire)	RS-485 (3-wire)
1 to 4	1	DCD	TXD-	TXD-	DATA-
	2	RXD	TXD+	TXD+	DATA+
	3	TXD	RXD+	RXD+	-----
	4	DTR	RXD-	RXD-	-----
	5	GND	GND	GND	GND
	6	DSR	-----	RTS-	-----
	7	RTS	-----	RTS+	-----
	8	CTS	-----	CTS+	-----
	9	RI	-----	CTS-	-----

COM 1 to COM 4 MB connector table:

COM Port	MB Connector	COM Port	MB Connector
COM 1	JCOM1	COM 2	JCOM2
COM 3	JCOM3	COM 4	JCOM4

COM 1 to COM 4 MB connector pin out:

CN	Pin No.	Signal Name
CN 9 (COM 3) CN 10 (COM 4)	1	Chassis GND
	2	GND
	3	RI
	4	DTR
	5	CTS
	6	TXD
	7	RTS
	8	RXD
	9	DSR
	10	DCD

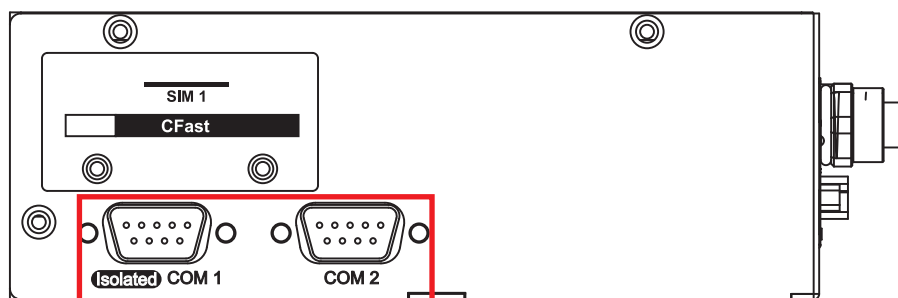

BIOS Setting	Function
COM 1 COM 2	RS-232
	RS-422 (5-wire)
	RS-422 (9-wire)
	RS-485
	RS-485 w/ auto-flow control

The pin assignments are listed in the table as below:

Serial Port	Pin No.	RS-232	RS-422 (5-wire)	RS-422 (9-wire)	RS-485 (3-wire)
1 to 2	1	DCD	TXD-	TXD-	DATA-
	2	RXD	TXD+	TXD+	DATA+
	3	TXD	RXD+	RXD+	-----
	4	DTR	RXD-	RXD-	-----
	5	GND	GND	GND	GND
	6	DSR	-----	RTS-	-----
	7	RTS	-----	RTS+	-----
	8	CTS	-----	CTS+	-----
	9	RI	-----	CTS-	-----

COM 1 to COM 2 MB connector table:

COM Port	MB Connector	COM Port	MB Connector
COM 1	JCOM1	COM 2	JCOM2

COM 1 to COM 2 MB connector pin out:

CN	Pin No.	Signal Name
JCOM1 (COM 1) JCOM2 (COM 2)	1	Chassis GND
	2	GND
	3	RI
	4	DTR
	5	CTS
	6	TXD
	7	RTS
	8	RXD
	9	DSR
	10	DCD

2.4.2 CFast Card

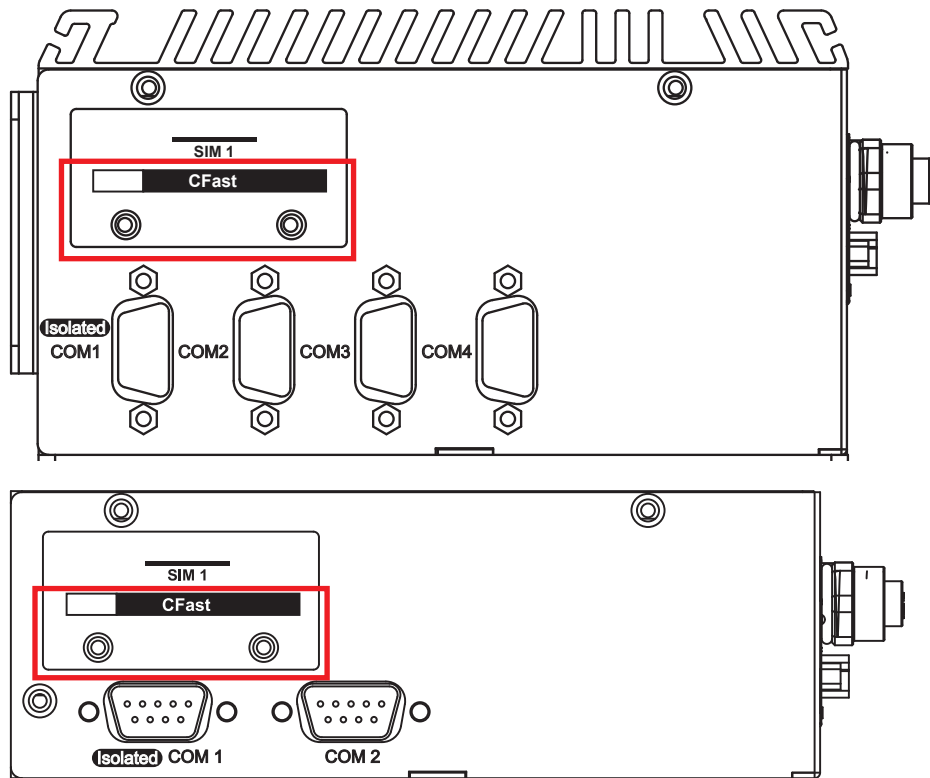

There is a CFast socket on the bottom side supporting Type-I/II Compact Flash card. It is implemented by a SATA III Port from PCH. Be sure to disconnect the power source and unscrew the CFast socket cover before installing a CFast card. ARS-2000 does not support the CFast hot swap and PnP (Plug and Play) functions. It is necessary to remove power source first before inserting or removing the CFast card.

The pinouts of CFast port are listed as follows:

Pin No.	Description	Pin No.	Description
S1	GND	PC6	NC
S2	SATA_TXP4	PC7	GND
S3	SATA_TXN4	PC8	CFAST_LED
S4	GND	PC9	NC
S5	SATA_RXN4	PC10	NC
S6	SATA_RXP4	PC11	NC
S7	GND	PC12	NC
PC1	GND	PC13	+3.3V
PC2	GND	PC14	+3.3V
PC3	NC	PC15	GND
PC4	NC	PC16	GND
PC5	NC	PC17	NC

2.4.3 Mini PCIe & SIM Card Comparison

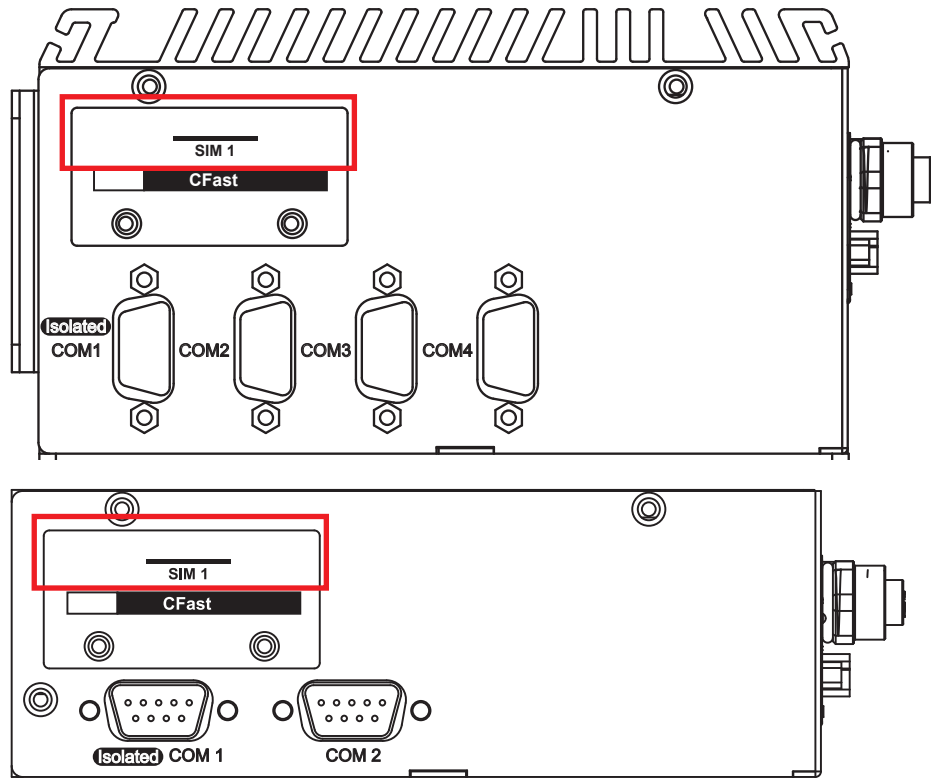

Mini PCIe Slot/SIM Slot Mapping Table:

Mini PCIe	SIM
Mini PCIe 1/ mSATA (CN13)	
Mini PCIe 2 (CN14)	SIM (CN15)

Mini PCIe 1/mSATA Select SW:

Jumper (JP4)	Interface
1-2	Auto Detection
3-4	Mini PCIe
1-3	mSATA

2.5 Main Board Expansion Connectors

2.5.1 Top View of ARS-2000 Main Board with Connector Location

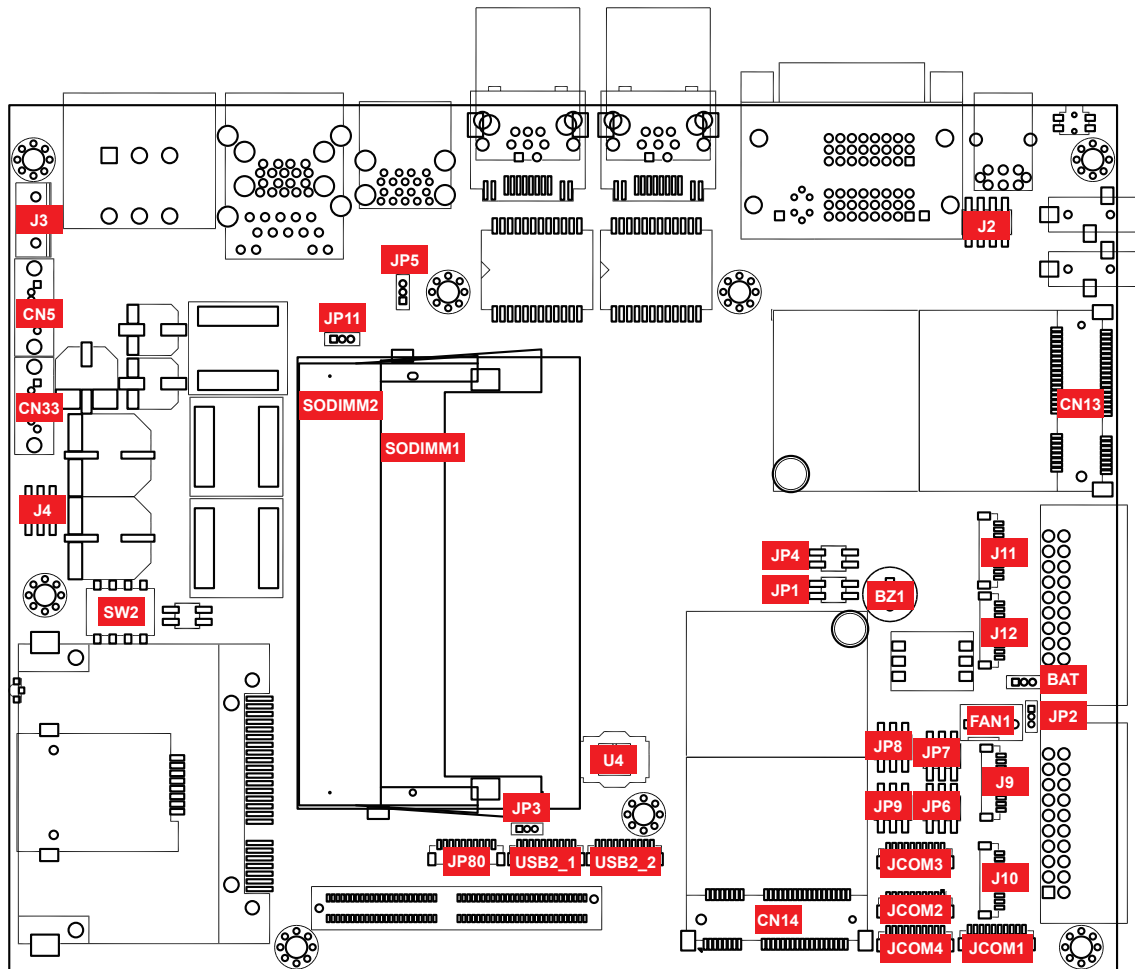

2.5.2 Bottom View of ARS-2000 Main Board with Connector Location

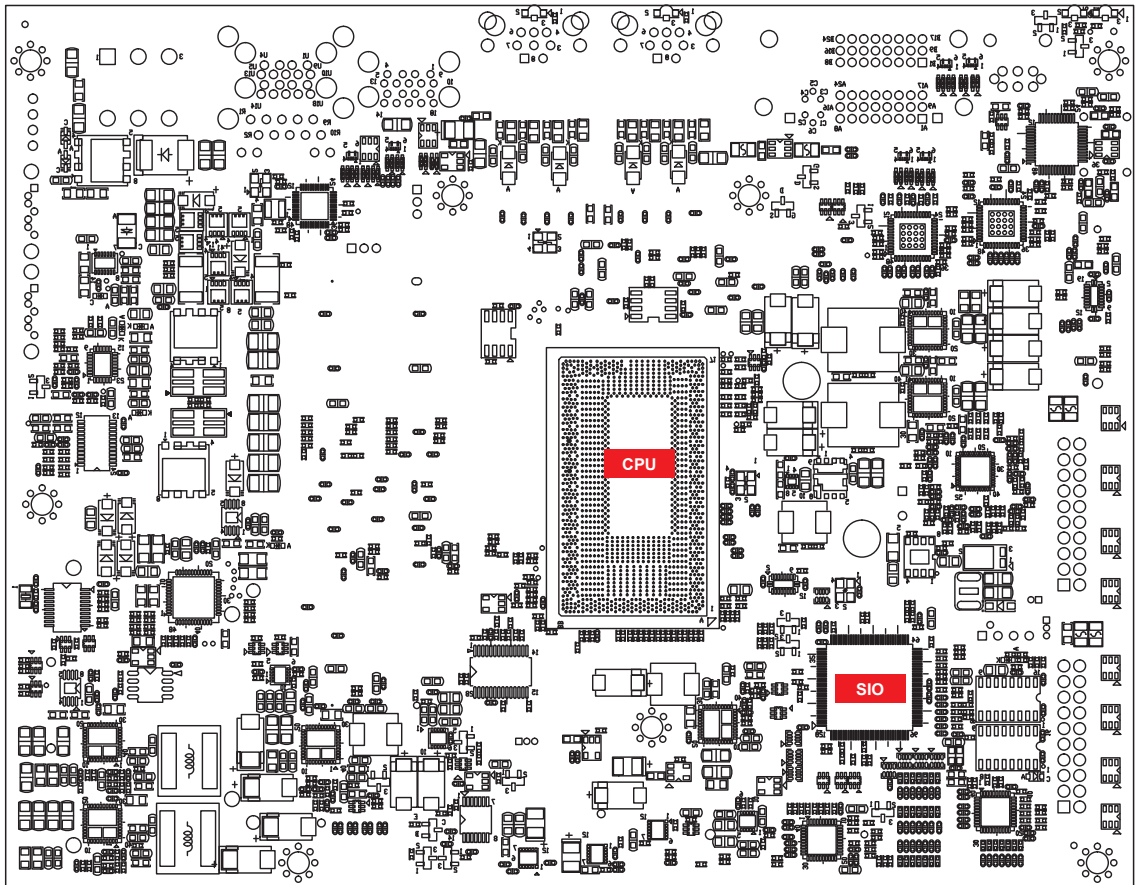

2.5.3 Miscellaneous Header

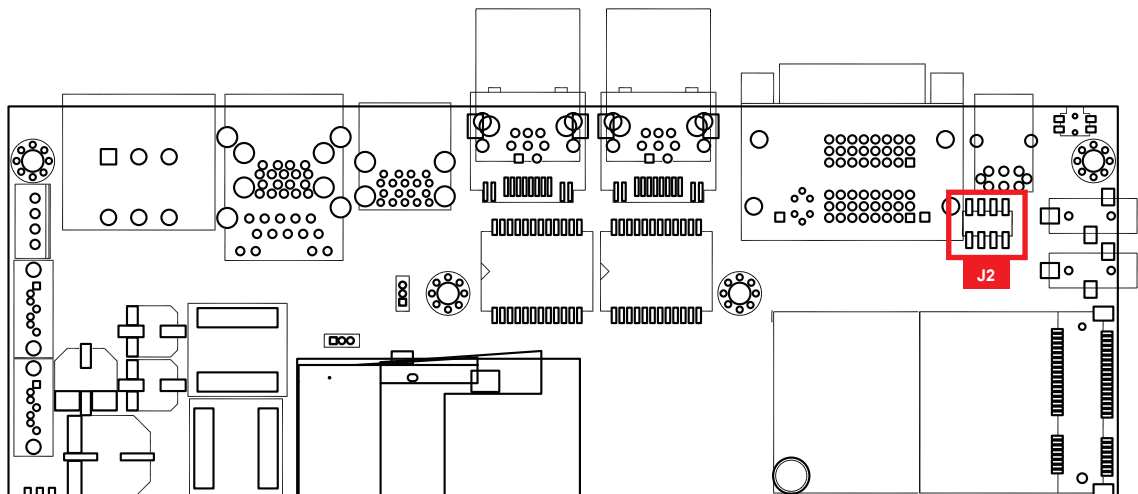

This Header can be used as a backup for following functions, such as hard drive LED indicator, reset button, power LED indicator, and power-on/off button, which already can be accessed by front panel and top panel. The pin-outs of Miscellaneous port are listed in following table:

Group	Pin No.	Description
HDD LED	1	HDD_LED_P
	3	HDD_LED_N
RESET BUTTON	5	FP_RST_BTN_N
	7	GND
POWER LED	2	PWR_LED_P
	4	PWR_LED_N
POWER BUTTON	6	FP_PWR_BTN_IN
	8	GND

2.5.4 DDR4 Slot

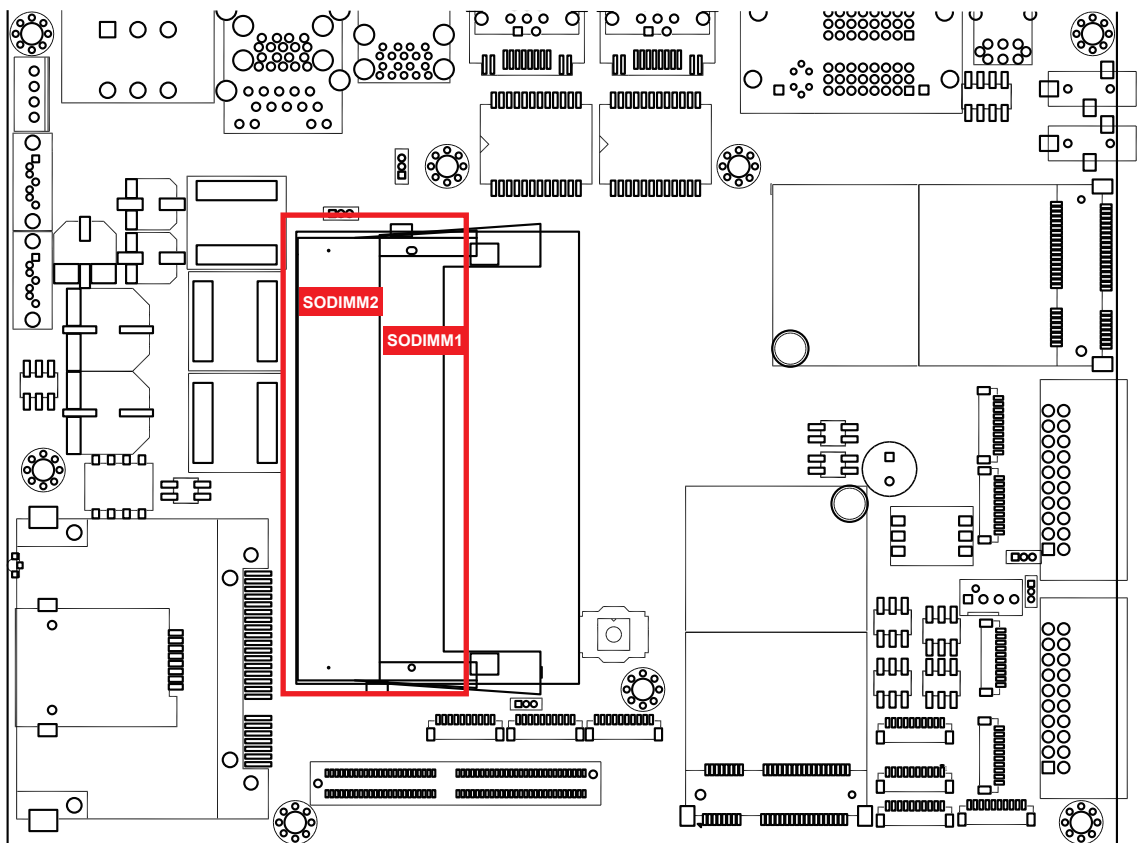

There are 2 DDR4 channels onboard supporting DDR4 2133/1866 and up to 32GB. (Each channel 16GB)

Slot	Description
SODIMM_1	DDR4 Channel A
SODIMM_2	DDR4 Channel B

2.5.5 SATA III Connector

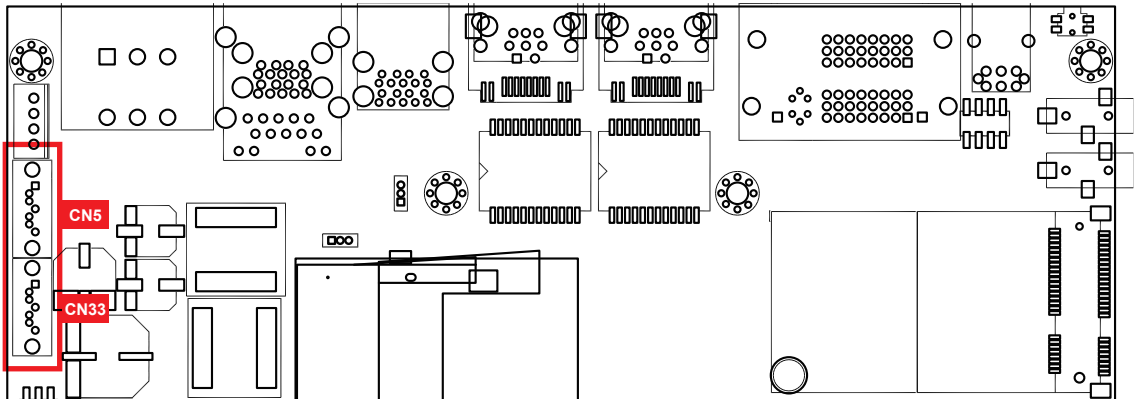

There are 2 onboard high performance Serial ATA III (SATA III) on ARS-2000. It supports higher storage capacity with less cabling effort and smaller required space. The pin assignments of CN11 and CN14 are listed in the following table:

Pin No.	Description	Pin No.	Description
1	GND	5	RXN
2	TXP	6	RXP
3	TXN	7	GND
4	GND		

2.5.6 SATA Power Header

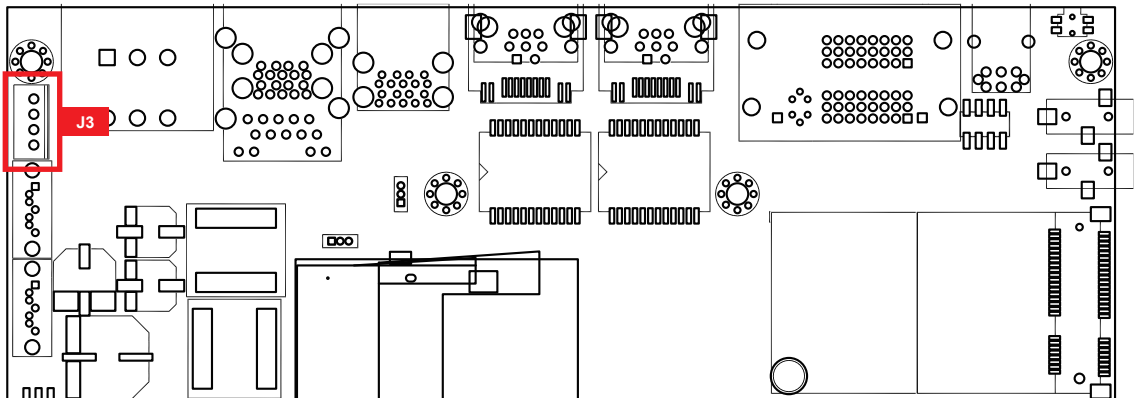

ARS-2000 is also equipped with 1 SATA power connector. It supports 5V (Up to 2A) and 12V (Up to 1A) current to the hard drive or SSD. The pin assignments of J3 is listed in the following table:

Pin No.	Description	Pin No.	Description
1	+12V	3	GND
2	GND	4	+5V

2.5.7 Mini PCIe/mSATA Slot

2.5.7.1 Mini PCIe/mSATA Slot (CN13)

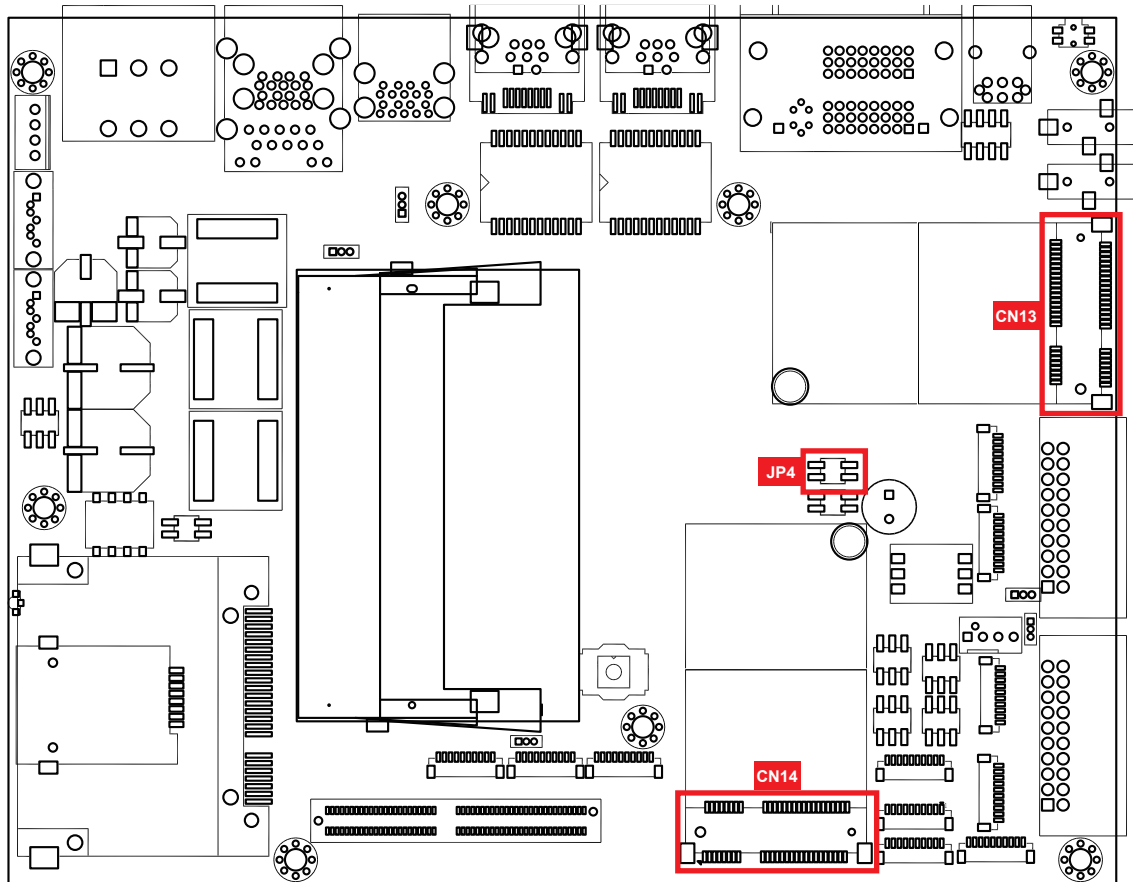

Both mSATA and Mini PCIe share the same form factor and similar electrical pinout assignments on their connectors. There is no clear mechanism to distinguish if a mSATA drive or a Mini PCIe device is plugged into the socket until recently that SATA I/O issued an ECN change (ECN #045) to redefine pin-43 on mSATA connector as “no connect” instead of “return current path” (or GND).

When an mSATA drive is inserted, its pin-43 is “no connect”, and the respective pin on the socket is being pulled-up to logic 1. When a Mini PCIe device is inserted, its pin-43 forces the respective pin on the socket to ground, or logic 0. ARS-2000 using JP4 Pin-43 status designed for switching between mSATA drive and Mini PCIe device.

Pin No.	Interface	Pin No.	Interface
1-2	Auto Detection	1-3	mSATA
2-4	Mini PCIe		

The pin assignments of CN13 are listed in the following table:

Pin No.	function	Pin No.	function
51	Reserved	52	+V3P3aux
49	Reserved	50	GND
47	Reserved	48	+1.5V
45	Reserved	46	Reserved
43	Status	44	Reserved
41	+V3P3aux	42	Reserved
39	+V3P3aux	40	GND
37	GND	38	USB_D+
35	GND	36	USB_D-
33	PETp0	34	GND
31	PETn0	32	SMB_DATA
29	GND	30	SMB_CLK
27	GND	28	+1.5V
25	PERp0	26	GND
23	PERn0	24	+V3P3aux
21	GND	22	PERST#
19	Reserved	20	reserved
17	Reserved	18	GND
Mechanical Key			
15	GND	16	UIM_VPP
13	REFCLK+	14	UIM_RESET
11	REFCLK-	12	UIM_CLK
9	GND	10	UIM_DATA
7	CLKREQ#	8	UIM_PWR
5	Reserved	6	1.5V
3	Reserved	4	GND
1	WAKE#	2	3.3Vaux

2.5.7.2 Mini PCIe (CN14)

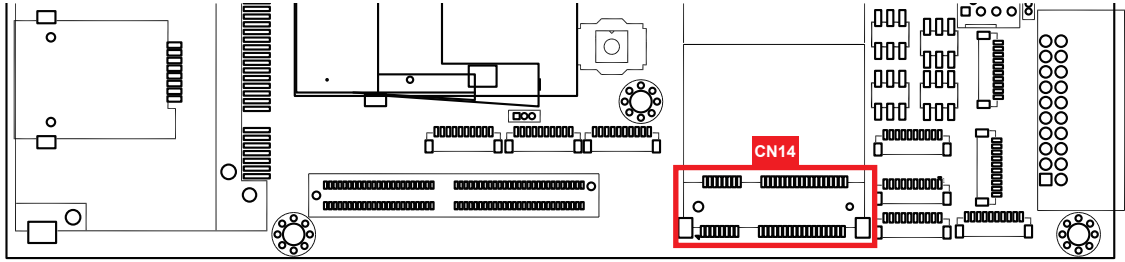

The pin assignments of CN14 are listed in the following table:

Pin No.	function	Pin No.	function
51	Reserved	52	+V3P3aux
49	Reserved	50	GND
47	Reserved	48	+1.5V
45	Reserved	46	Reserved
43	GND	44	Reserved
41	+V3P3aux	42	Reserved
39	+V3P3aux	40	GND
37	GND	38	USB_D+
35	GND	36	USB_D-
33	PETp0	34	GND
31	PETn0	32	SMB_DATA
29	GND	30	SMB_CLK
27	GND	28	+1.5V
25	PERp0	26	GND
23	PERn0	24	+V3P3aux
21	GND	22	PERST#
19	Reserved	20	reserved
17	Reserved	18	GND
Mechanical Key			
15	GND	16	UIM_VPP
13	REFCLK+	14	UIM_RESET
11	REFCLK-	12	UIM_CLK
9	GND	10	UIM_DATA

7	CLKREQ#	8	UIM_PWR
5	Reserved	6	1.5V
3	Reserved	4	GND
1	WAKE#	2	3.3Vaux

2.5.8 RTC Battery

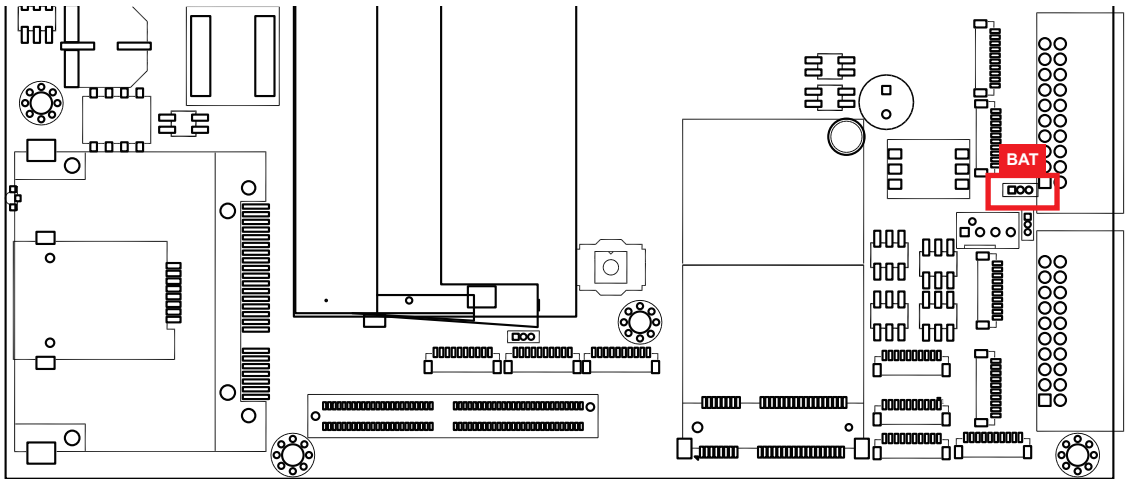

ARS-2000 real-time clock is powered by a lithium battery. It is equipped with Panasonic BR2032 190mAh lithium battery. It is recommended that do not replace the lithium battery on your own. If the battery need to be changed, please contact the Vecow RMA service team.

2.5.9 BIOS Socket

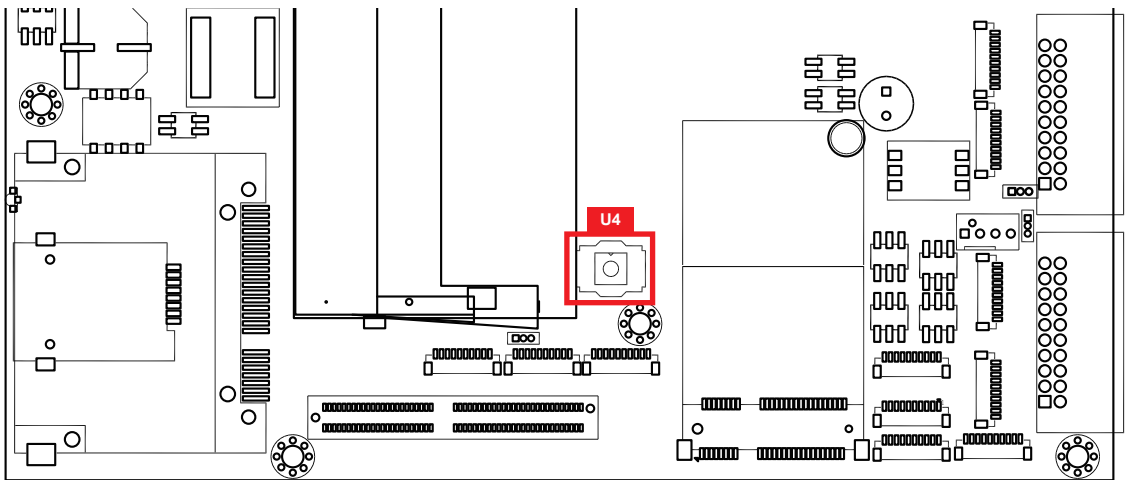

If the BIOS need to be changed, please contact the Vecow RMA service team.

2.5.10 FAN Header

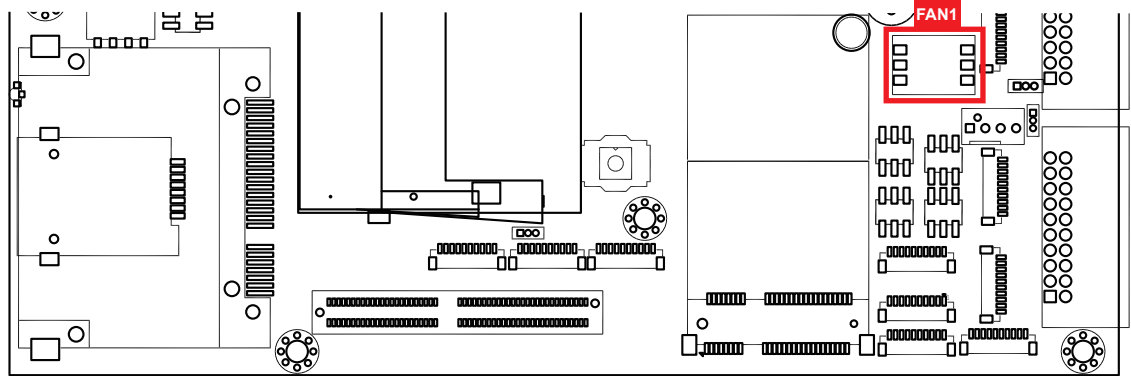

Fan power connector supports for additional thermal requirements. The pin assignments of FAN 1 and FAN 2 are listed in the following table.

Pin Out :

Pin No.	Function	Pin No.	Function
1	GND	3	Fan speed sensor
2	+12V (1.5A max)	4	Fan PWM

2.5.11 LPC Port 80 Header

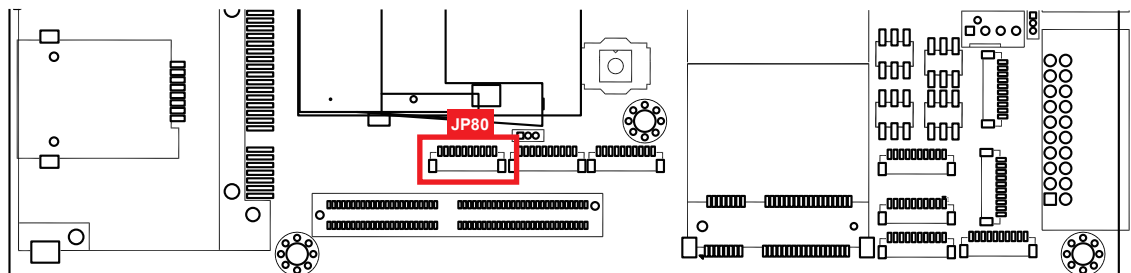

ARS-2000 provides a LPC Port 80 Header for Debug Card.

2.5.12 Internal USB 2.0

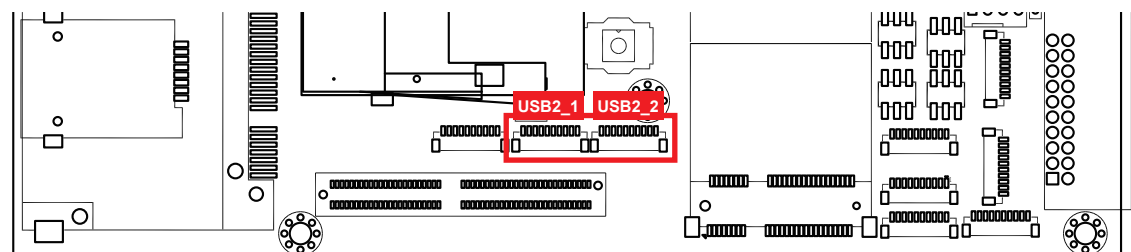

ARS-2000 main board provides 4 expansion USB ports using plug-and-play for Dongle Key. The USB interface supports 480 Mbps transfer rate complied with high speed USB specification Rev. 2.0.

The USB interface is accessed through two 10-pin JST 1.0mm connectors. You will need an adapter cable if you use a standard USB connector.

2.6 Main Board Jumper & DIP Switch Settings

2.6.1 Top View of ARS-2000 with Jumper and DIP Switch

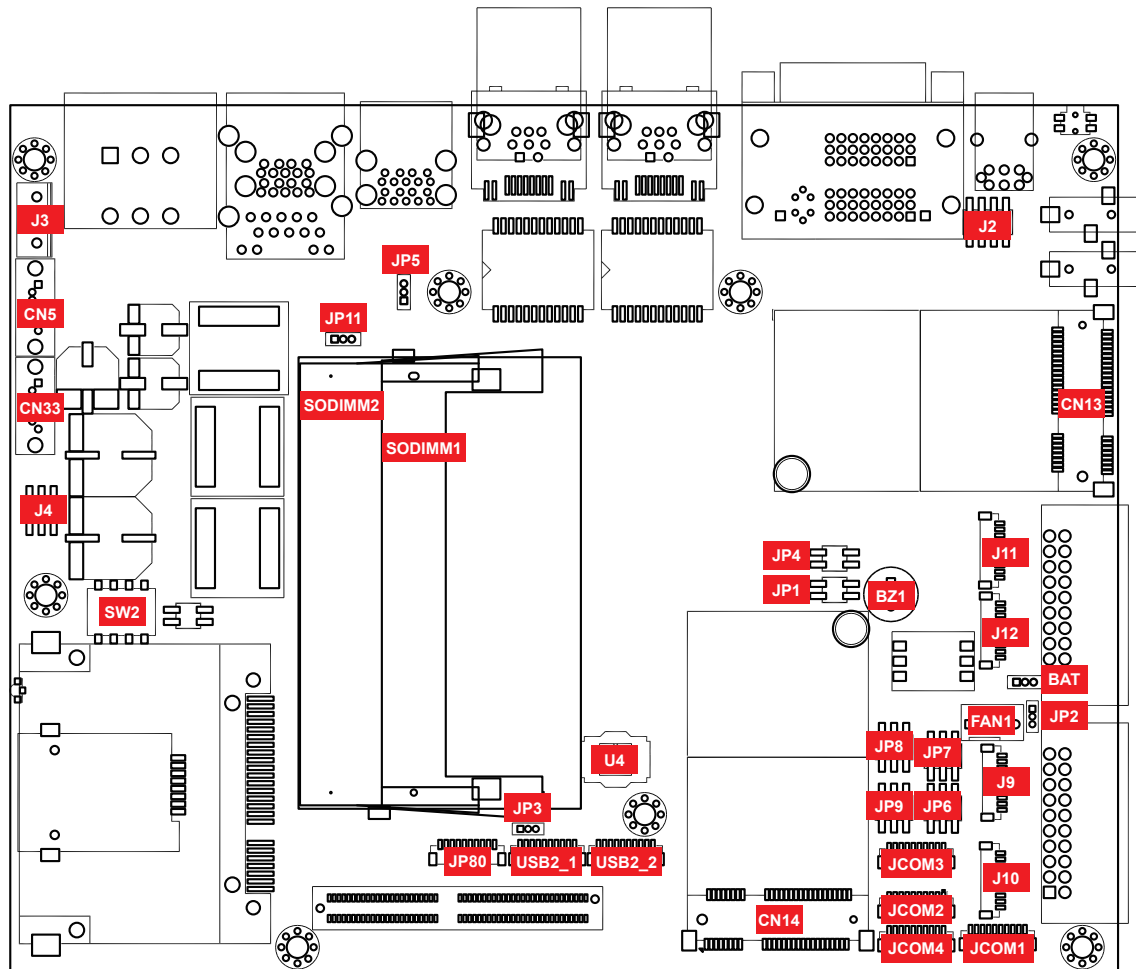

The figure below is the top view of ARS-2000 board, and it shows the location of the jumpers and the switches.

You may configure your card to match the needs of your application by setting jumpers. A jumper is a metal bridge used to close an electric circuit. It consists of two metal pins and a small metal clip (often protected by a plastic cover) that slides over the pins to connect them. To “close” a jumper, please connect the pins with the clip. To “open” a jumper, please remove the clip. Sometimes a jumper will have three pins, labeled 1, 2, and 3. In this case you would connect either pins 1 and 2, or 2 and 3.

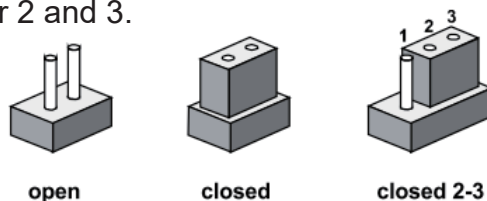

2.6.2 COM Port RI Pin Select

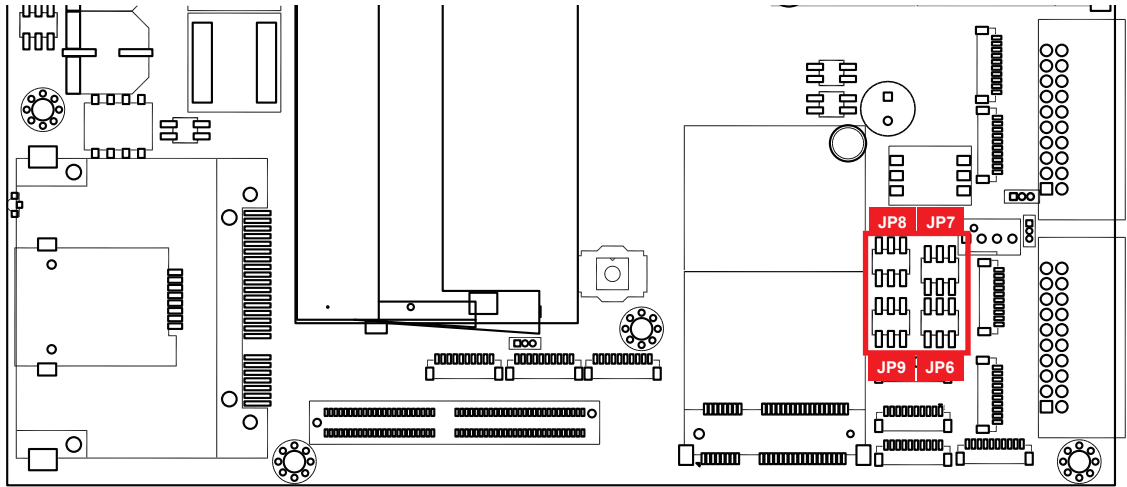

Pin Header	Pin No.	Description
COM1 JP6	1-2	+5V (1A max.)
	3-4	+12V (0.5A max.)
	5-6	RI (Default)

Pin Header	Pin No.	Description
COM2 JP7	1-2	+5V (1A max.)
	3-4	+12V (0.5A max.)
	5-6	RI (Default)

Pin Header	Pin No.	Description
COM3 JP8	1-2	+5V (1A max.)
	3-4	+12V (0.5A max.)
	5-6	RI (Default)

Pin Header	Pin No.	Description
COM4 JP9	1-2	+5V (1A max.)
	3-4	+12V (0.5A max.)
	5-6	RI (Default)

2.6.3 PoE Power ON Select

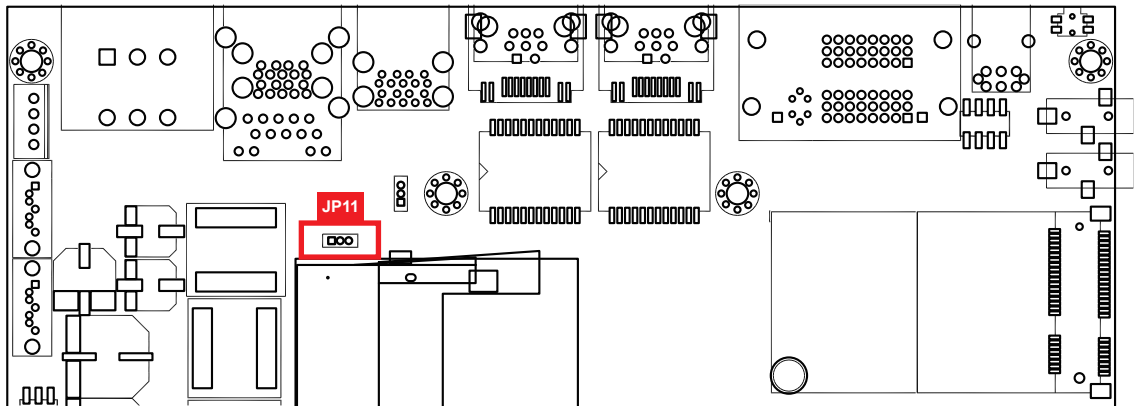

Jumper	Pin No.	Function
JP11	1 - 2	PoE power on at standby power ready
	2 - 3	PoE power on after system power on (Default)

2.6.4 SATAIII & mSATA Select

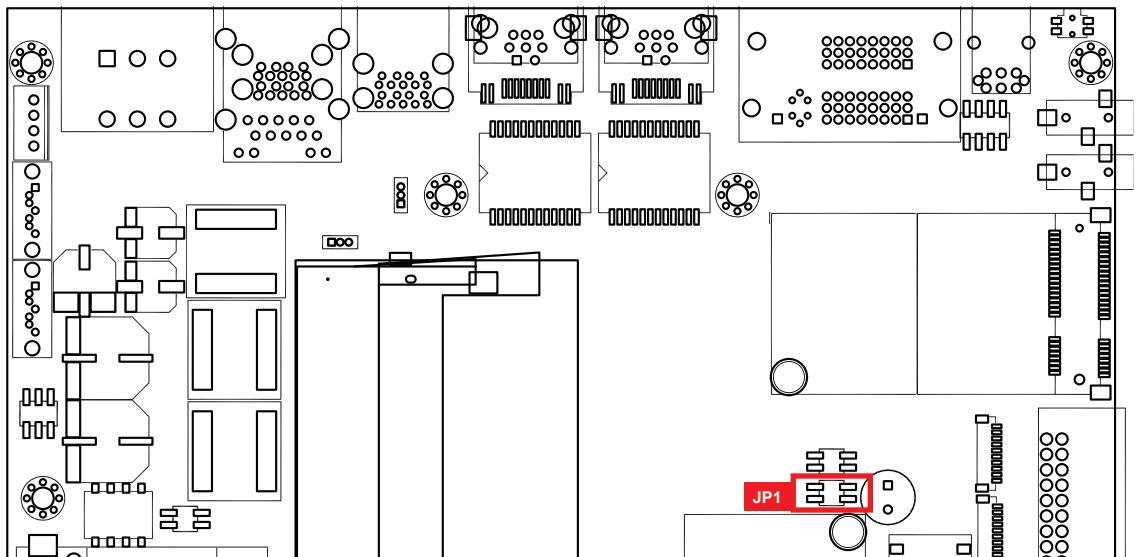

Jumper	Pin No.	Function
JP1	1 - 2	Spport on board SATA III
	3 - 4	Spport mSATA interface for Mini PCIe 1 (CN13)

2.6.5 USB Power Jumper

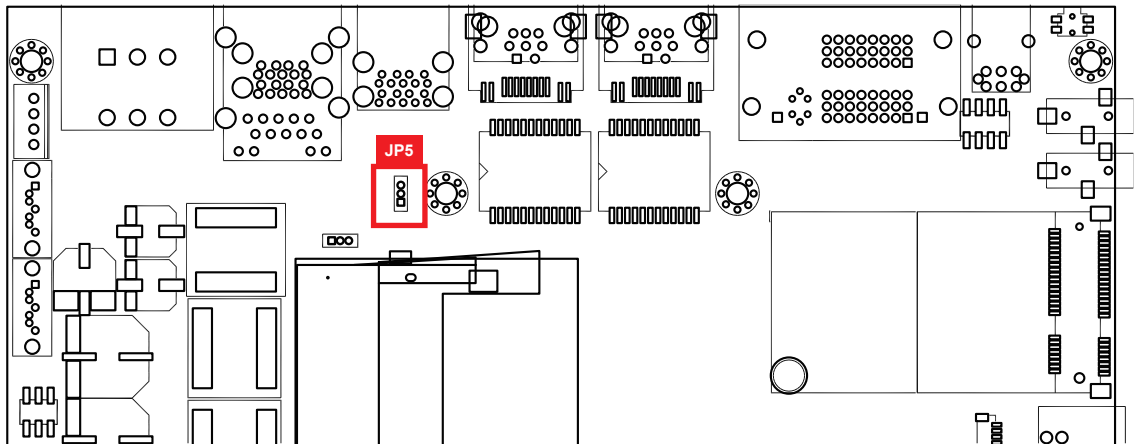

Jumper	Pin No.	Function
JP5	1 - 2	Supported Wake Up (Default)
	2 - 3	Non Wake Up support

2.6.6 Clear ME/CMOS

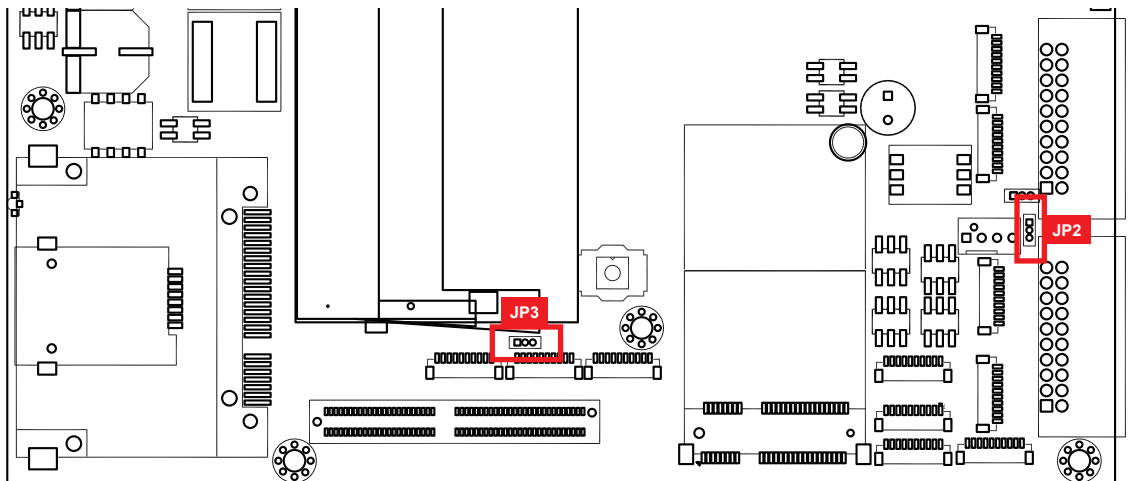

Jumper	Pin No.	Function
JP2 (CMOS)/ JP3 (ME)	1-2	+V3P3 (Default)
	2-3	GND

2.6.7 MCU Spy-bi Wire Interface for Download FW

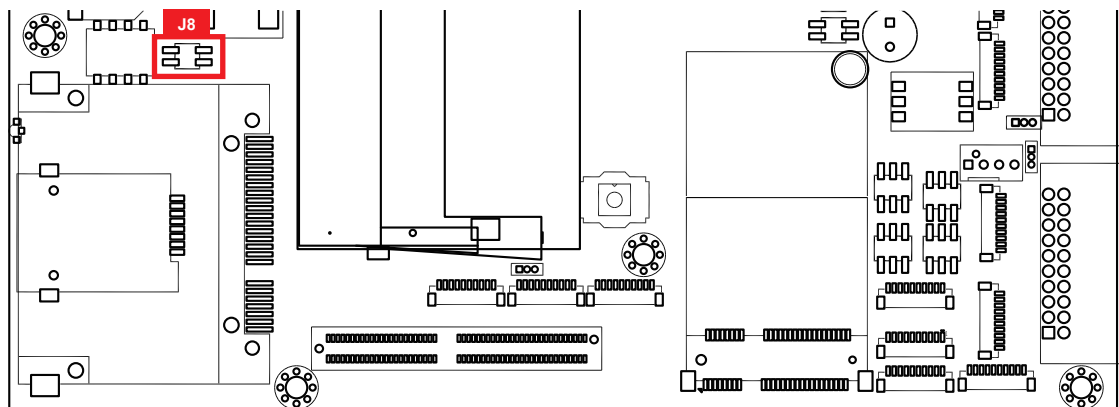

The pin assignments of J8 are listed in the following table:

Pin No.	Function	Pin No.	Function
1	GND	3	3.3V_MCU
2	MCU_RST#	4	MCU_PRG



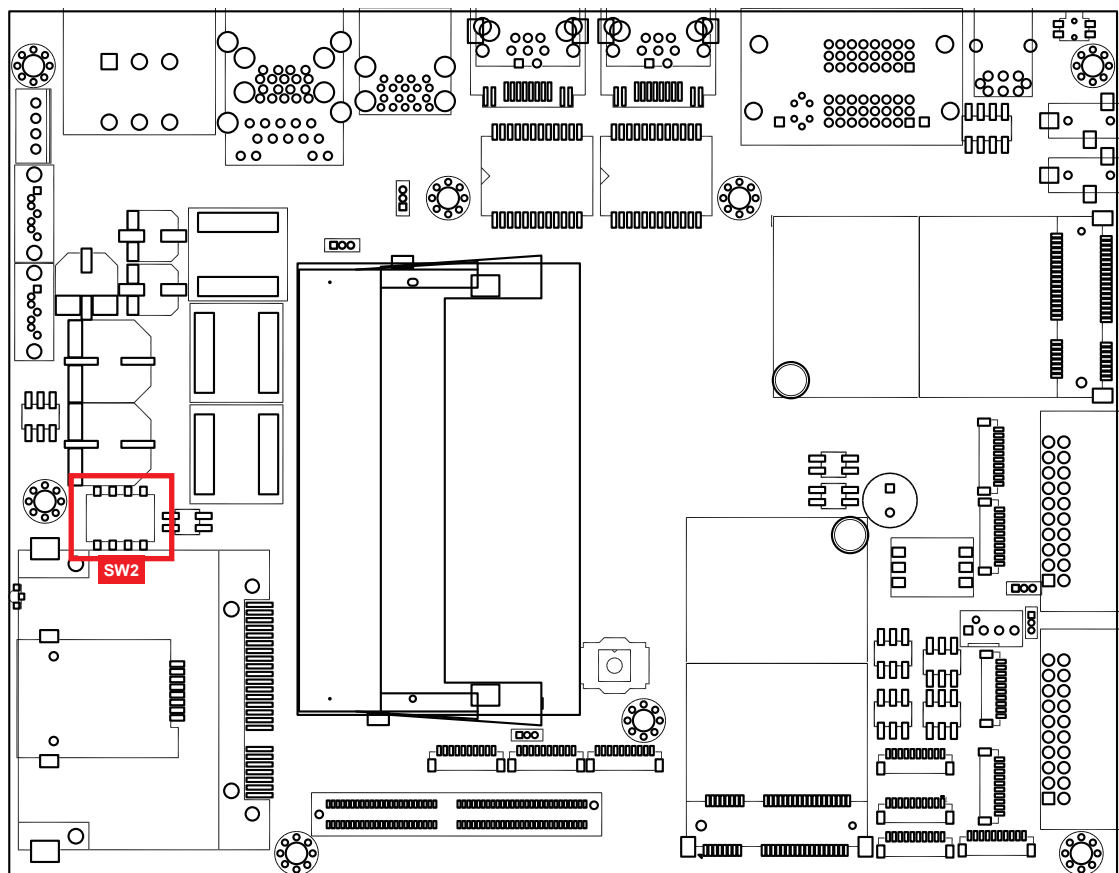





2.7 Ignition Control

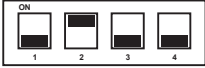
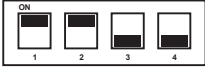

ARS-2000 series provides ignition power control feature for vehicle applications. The built-in MCU monitors the ignition signal and turns on/off the system according to pre-defined on/off delay periods.

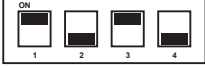
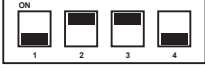
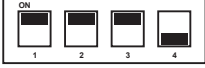
2.7.1 Adjust Ignition Control Modes

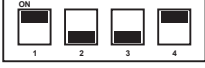
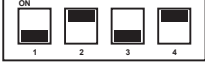
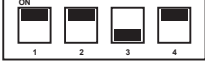
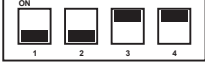
ARS-2000 series provides 16 modes of different power on/off delay periods adjustable via rotary switch. The default rotary switch is set to 0 in ATX/AT power mode. The modes are listed in below table:

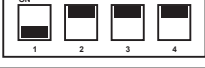
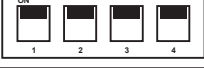
Item	Power on delay	Power off delay	Switch Position
0	ATX mode		
1	No delay	No delay	
2	No delay	5 seconds	
3	No delay	10 seconds	
4	No delay	20 seconds	
5	5 seconds	30 seconds	
6	5 seconds	60 seconds	
7	5 seconds	90 seconds	
8	5 seconds	30 minutes	
9	5 seconds	1 hour	
A	10 seconds	2 hours	
B	10 seconds	4 hours	
C	10 seconds	6 hours	
D	10 seconds	8 hours	
E	10 seconds	12 hours	
F	10 seconds	24 hours	

2.7.2 Ignition Control Wiring

To activate ignition control, you need to provide IGN signal via the 3-pin pluggable terminal block located in the back panel. Please find below the general wiring configuration.



Pin No.	Definition
1	Ignition (IGN)
2	External Power S/W +
3	External Power S/W +



For testing purpose, you can refer to the picture above to simulate ignition signal input controlled by a latching switch.

V+ Positive polarity of DC power input (Car battery+ for 12/24V)

V- Ground of DC power input (Car battery -/GND line to GND)

IGN Ignition signal input (ACC power of vehicle)

Note:

1. DC power source and IGN share the same ground.
2. ARS-2000 supports 6V to 36V wide range DC power input in ATX/AT mode. In Ignition mode, the input voltage is fixed to 12V/24V for car battery scenario.
3. For proper ignition control, the power button setting should be "Power Down" mode.

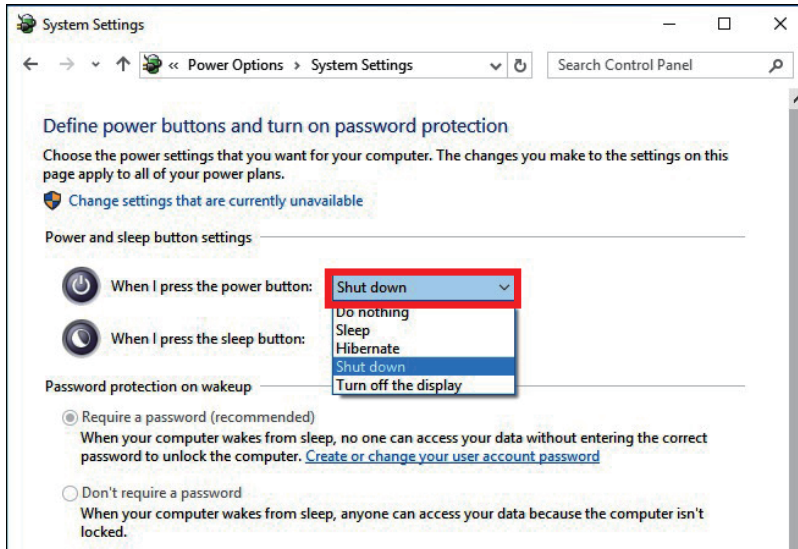

In Windows, for example, you need to set “When I press the power button” to “Shut down.”

2.7.3 Smart Battery Protection

The system with “Ignition Control” can perform Smart Battery Protection, namely Low Battery Detection.

When the system is running on a battery and its voltage drops below the threshold, the system will automatically shut down. The Low Battery Detection is implemented in the ignition control MCU FW and as a default function.

Note:

Battery Voltage	Thresholds
12V	10.5~15V
24V	21.5~30V

3

SYSTEM SETUP

3.1 How to Open Your ARS-2000

Step 1 Remove four F-M3x4 screws.

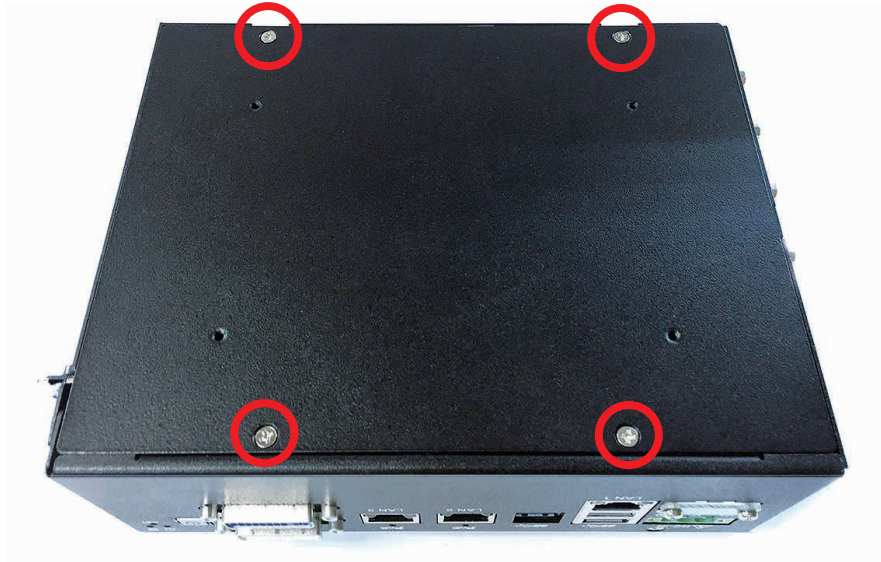

Step 2 Open this cover and removed SATA and SATA Power cable.

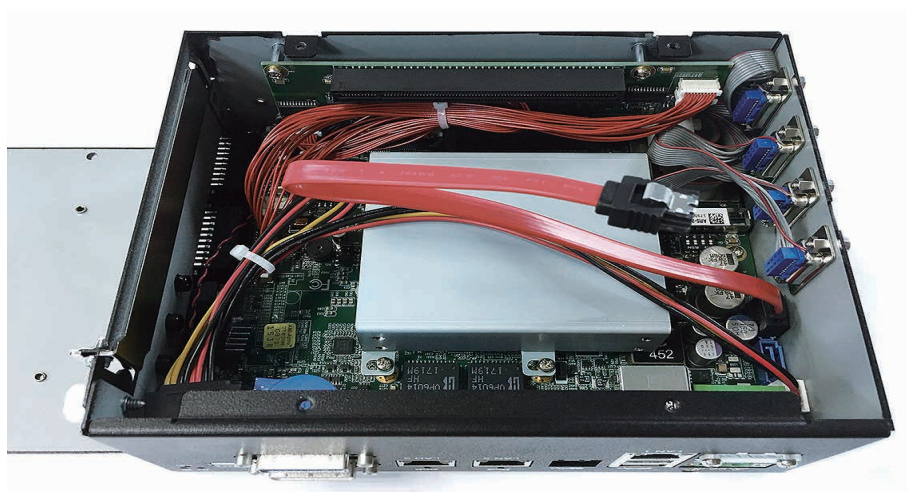

Step 3 Remove three PH-M3x6L screws.

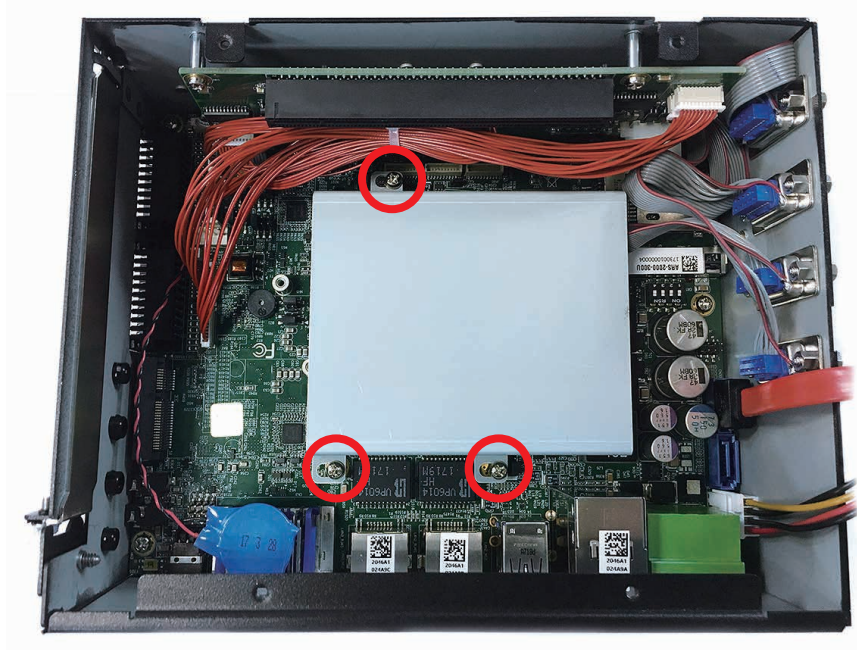

Step 4 Finish.

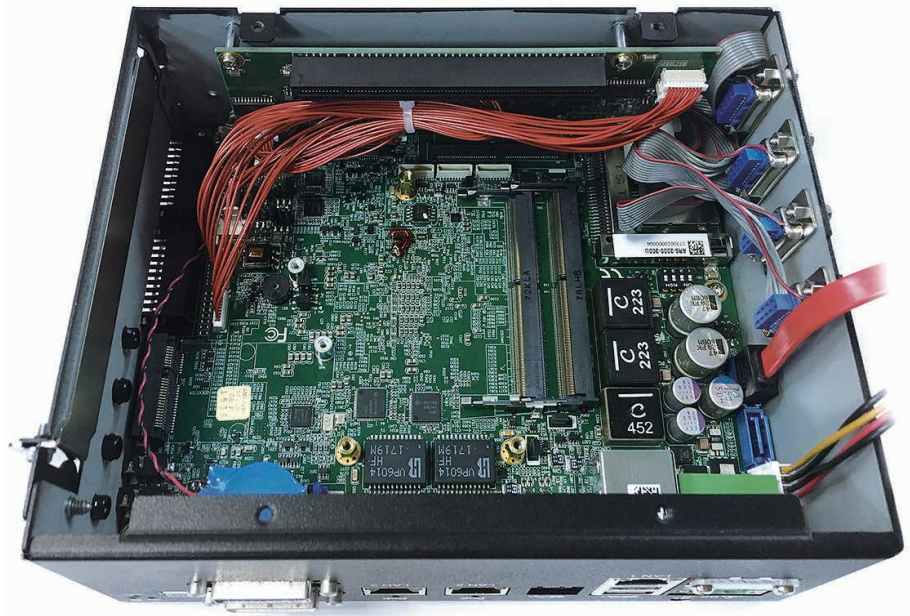

3.2 Installing DDR4 SO-DIMM Module

Step 1 Install DDR4 RAM module into SO-DIMM slot.

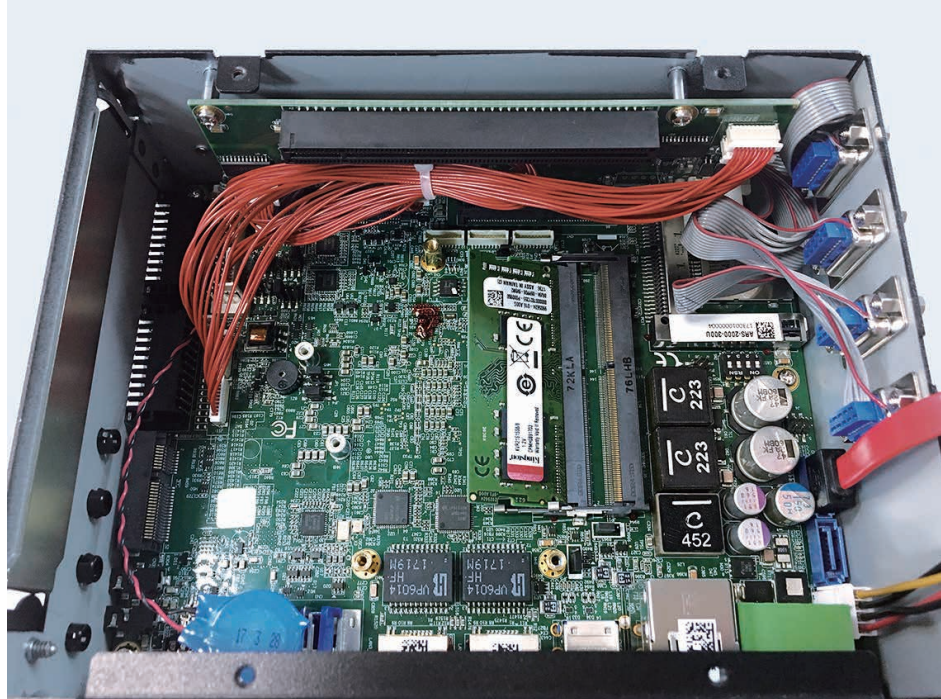

Step 2 Make sure RAM module is locked by the memory slot.

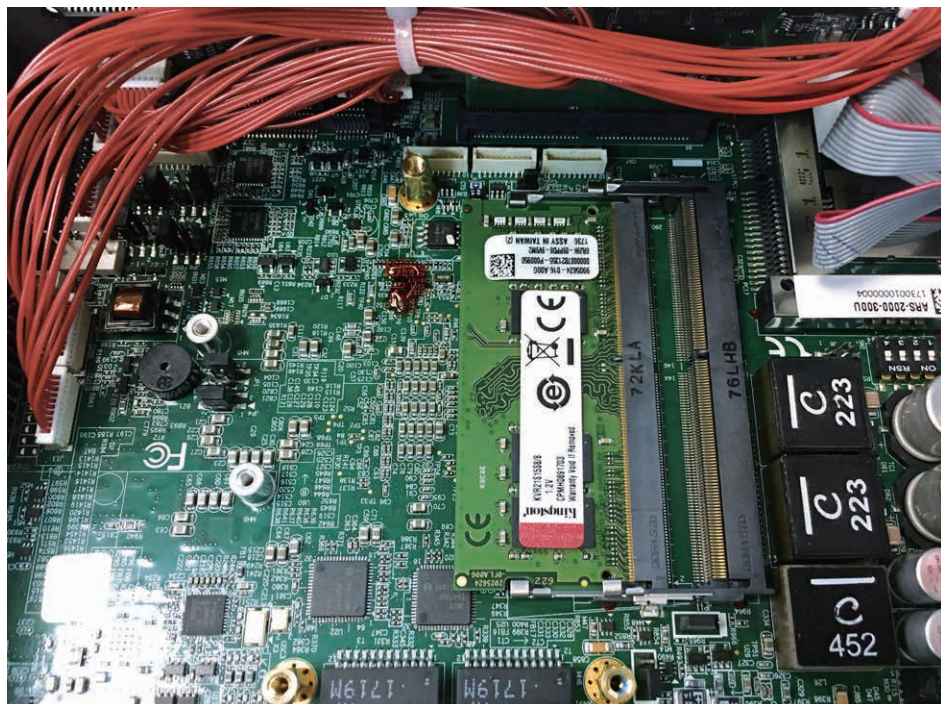

3.3 Installing Mini PCIe Card

Step 1 Install Mini PCIe card into the Mini PCIe slot.

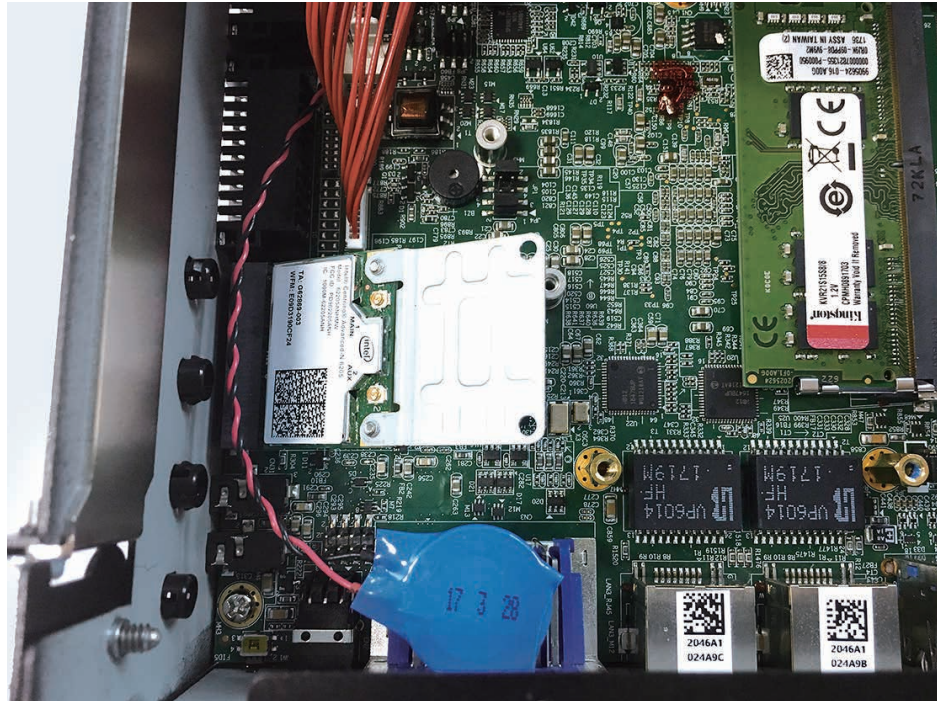

Step 2 Fasten one M2.5 screw.

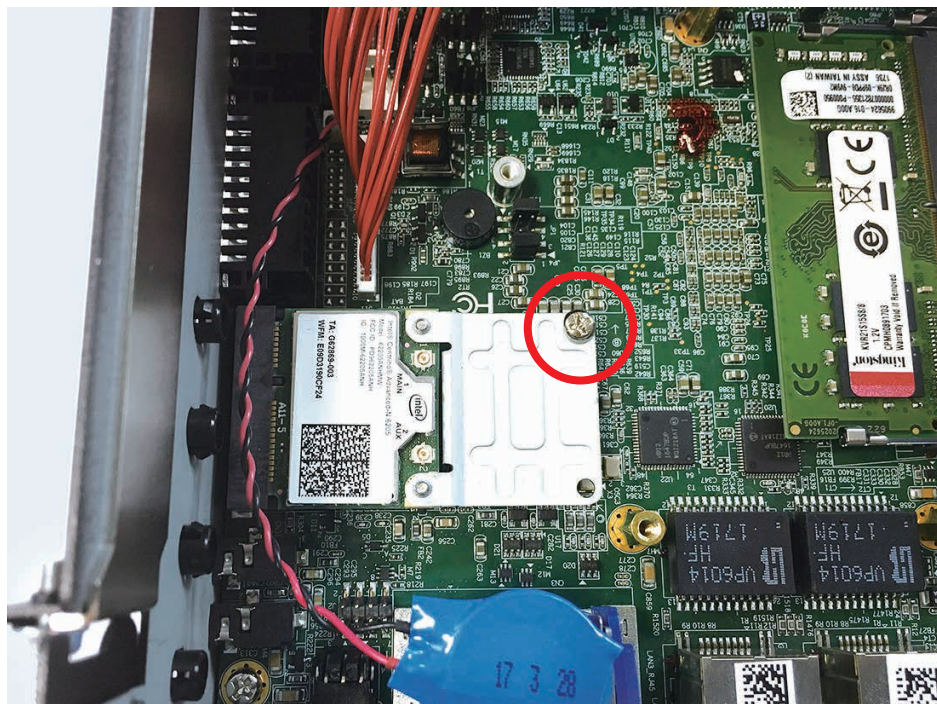

3.4 Installing Antenna Cable

Step 1 Remove plug.

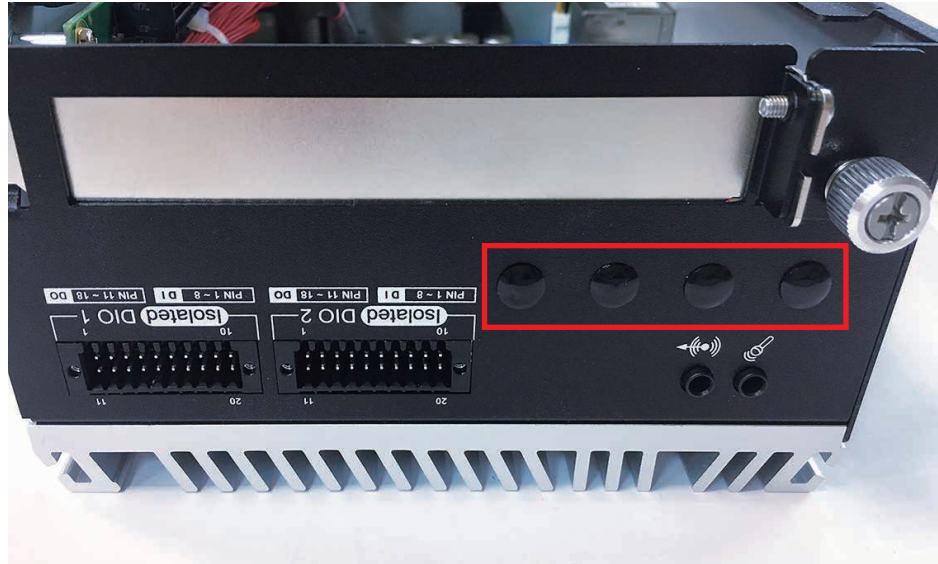

Step 2 Prepare your Antenna cable, washer, nut.



Step 3 Put Antenna cable connector into panel. Put on washer and fasten nut.



Step 4 Finish.



3.5 Installing CFast Card

Step 1 Remove two M3x4L screws on the cover.



Step 2 CFast card slot.

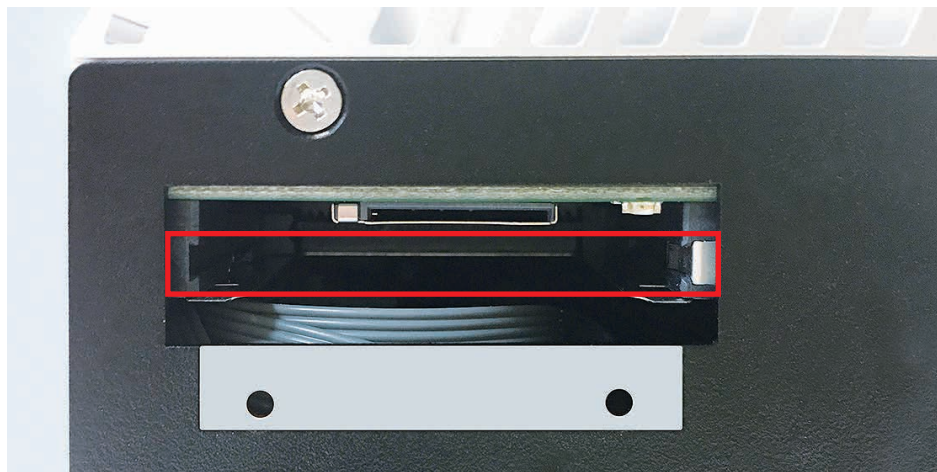

Step 3 Insert CFast card push to lock.



3.6 Installing SIM Card

Step 1 Remove two M3x4L screws on the cover.



Step 2 SIM card slot.



Step 3 Insert SIM card push to lock.

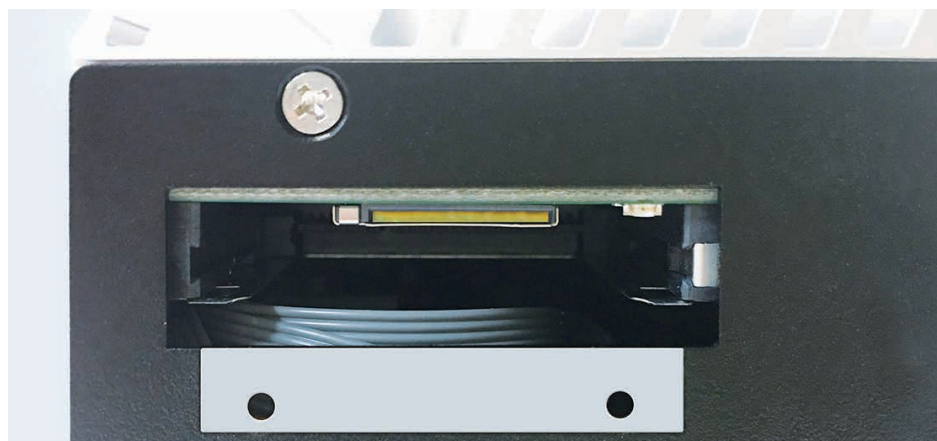

3.7 Installing SSD/HDD

Step 1 Install SSD/HDD with HDD bracket.



Step 2 Lock M3 screws. (one SSD/HDD with four M3 screws)



Step 3 Finish locked screws.



Step 4 Install SATA, power SATA cable with SSD/HDD and fasten three M3x6 screws.

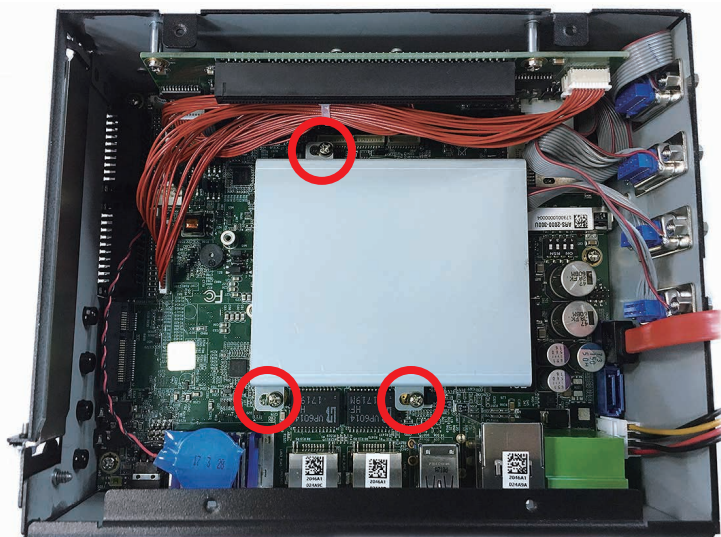

3.8 Installing PCI/PCIe Card (NOT for LIGHT version)

Step 1 Remove the bottom cover.



Step 2 Remove one M3 screw with Add-on-card bracket.



Step 3 Install PCIe/PCI card to the socket.



Step 4 Fasten the M3 screw.

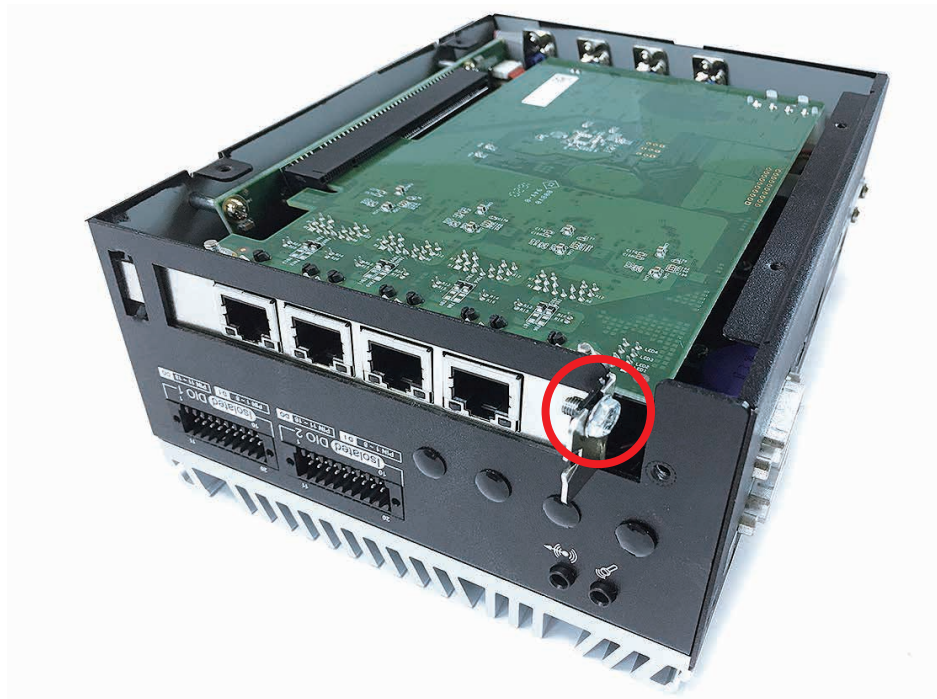

3.9 Mounting Your ARS-2000

3.9.1 Wall Mount (Default)

Step 1 Fasten wall mount with ARS-2000.

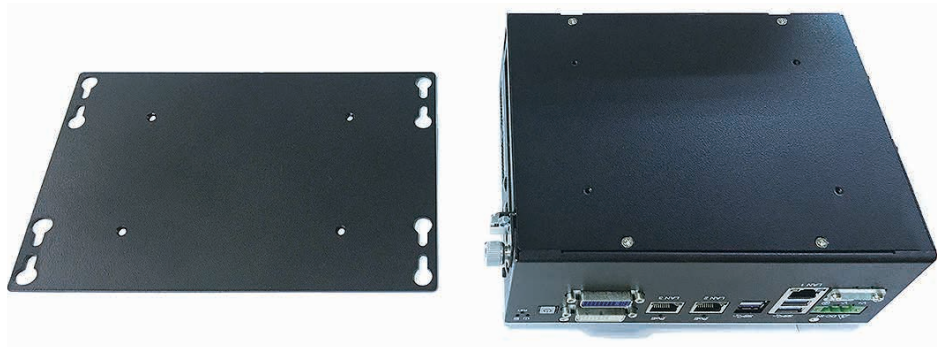

Step 2 Fasten four F-M3x4L screws.



Step 3 Finish.



3.9.1 Din Rail Kit

Step 1 Fasten DIN Rail Kit with ARS-2000.

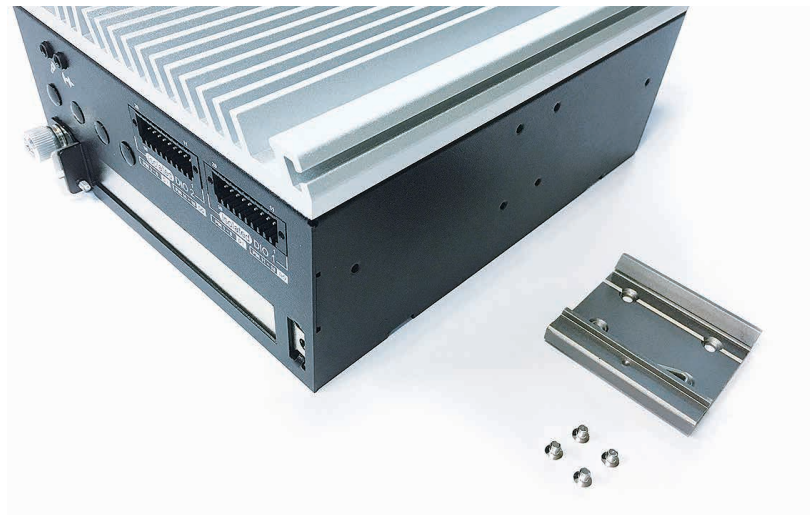

Step 2 Fasten four F-M3x4L screws.



Step 3 Finish.



4

BIOS SETUP

4.1 Entering BIOS SETUP

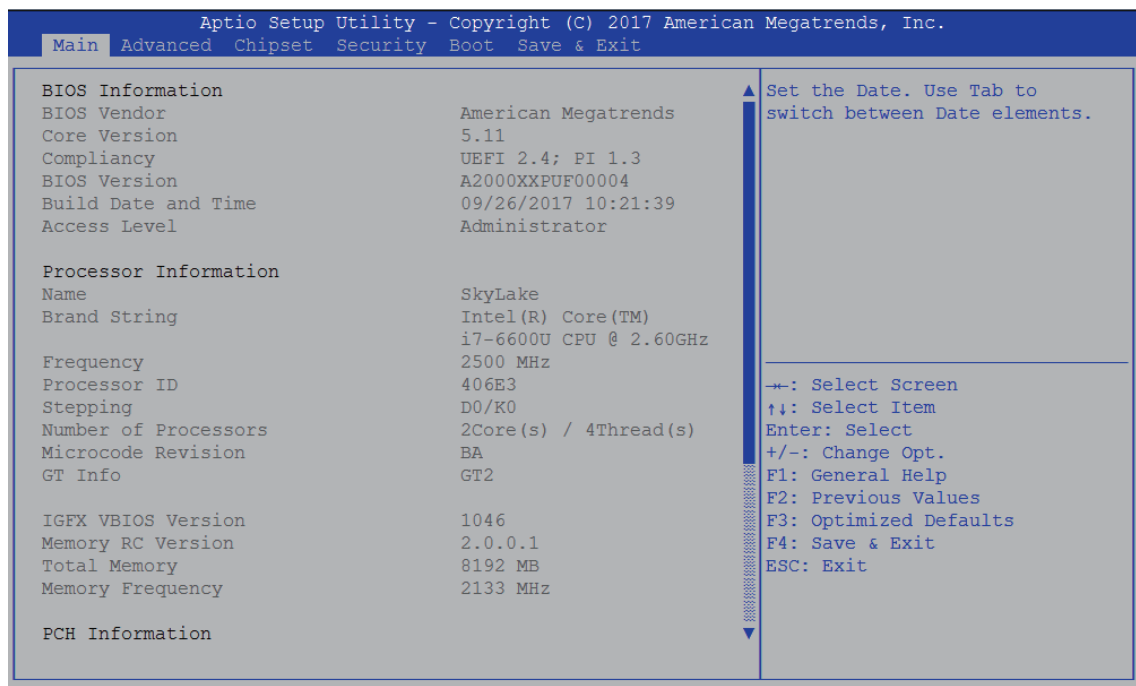

Figure 4-1: Entering Setup Screen

BIOS provides an interface for users to check and change system configuration. The BIOS setup program is accessed by pressing the key when POST display output is shown.

4.2 Main

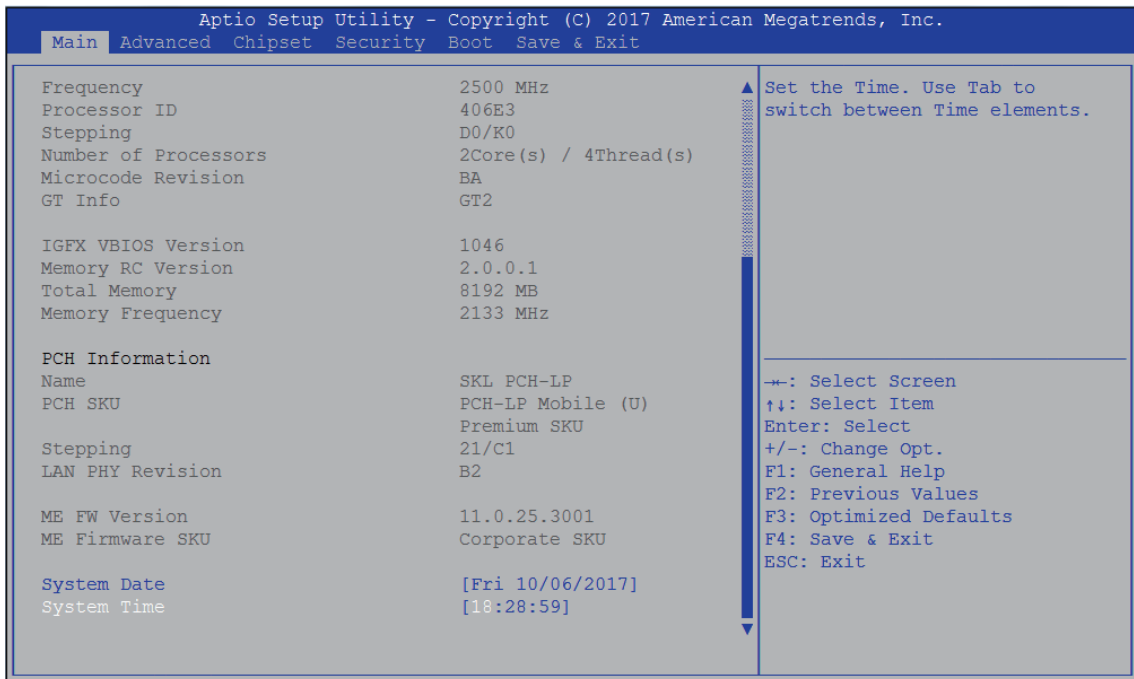

Figure 4-2: BIOS Main Menu

The main menu displays BIOS version and system information. There are two options on the main menu, system date and system time.

System Date

Set the date. Use <Tab> to switch between date elements.

System Time

Set the time. Use <Tab> to switch between time elements.

4.3 Advanced

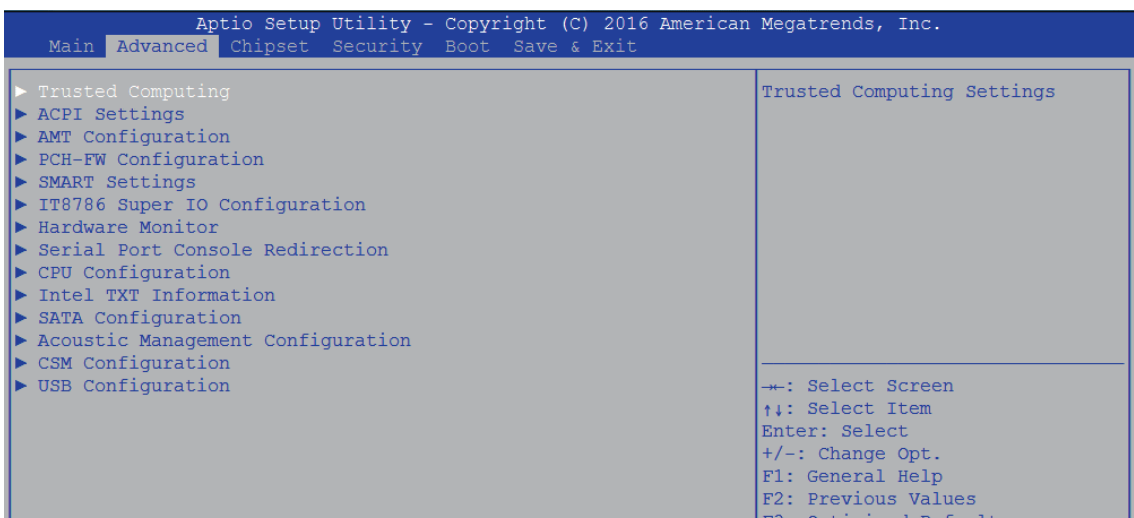

Figure 4 3: BIOS Advanced Menu

Select advanced tab to enter advanced BIOS setup options such as CPU configuration, SATA configuration, and USB configuration.

4.3.1 Trusted Computing

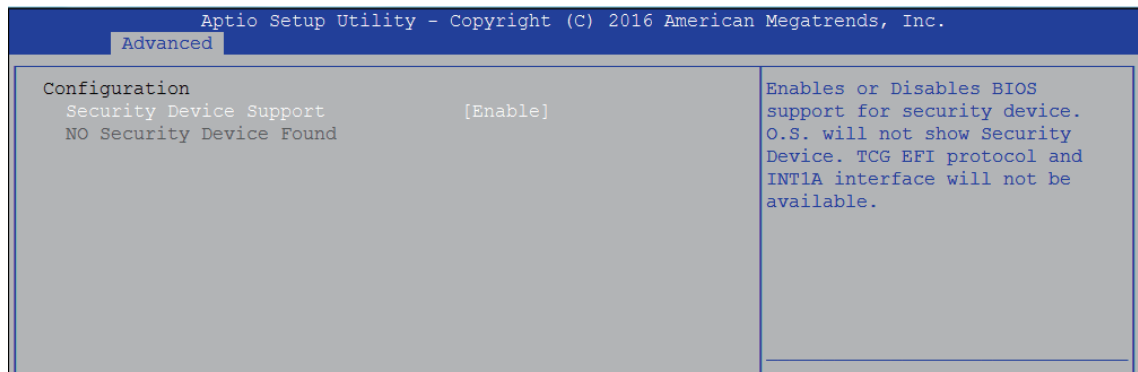

Figure 4 3-1: Trusted Computing

Control the TPM device status and display related information if TPM chip is present.

4.3.2 ACPI Settings

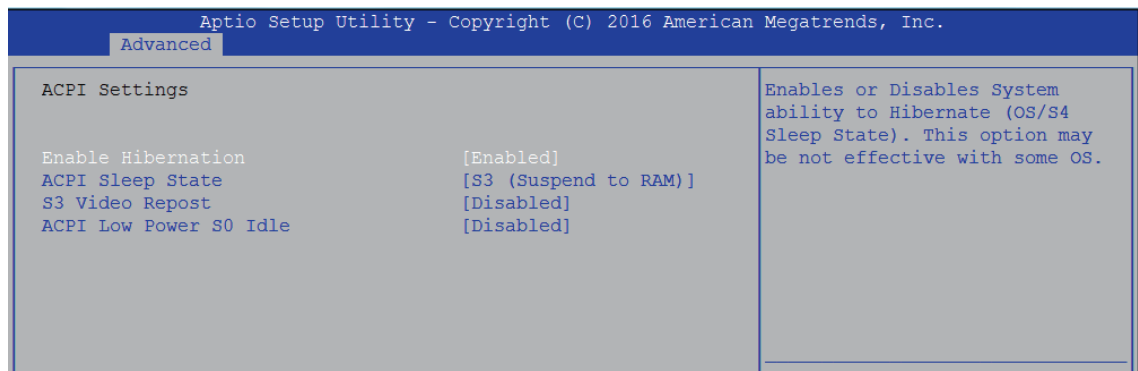

Figure 4 3-2: ACPI Settings

Enable Hibernation

Enables or disables system's ability to hibernate (OS/S4 sleep state). This option may not be effective with some OS.

ACPI Sleep State

Selects the highest ACPI sleep state the system will enter when the SUSPEND button is pressed.

S3 Video Repost

Enables or disables S3 video repost.

ACPI Low Power S0 Idle

Enables or disables ACPI low power S0 idle support.

4.3.3 AMT Configuration

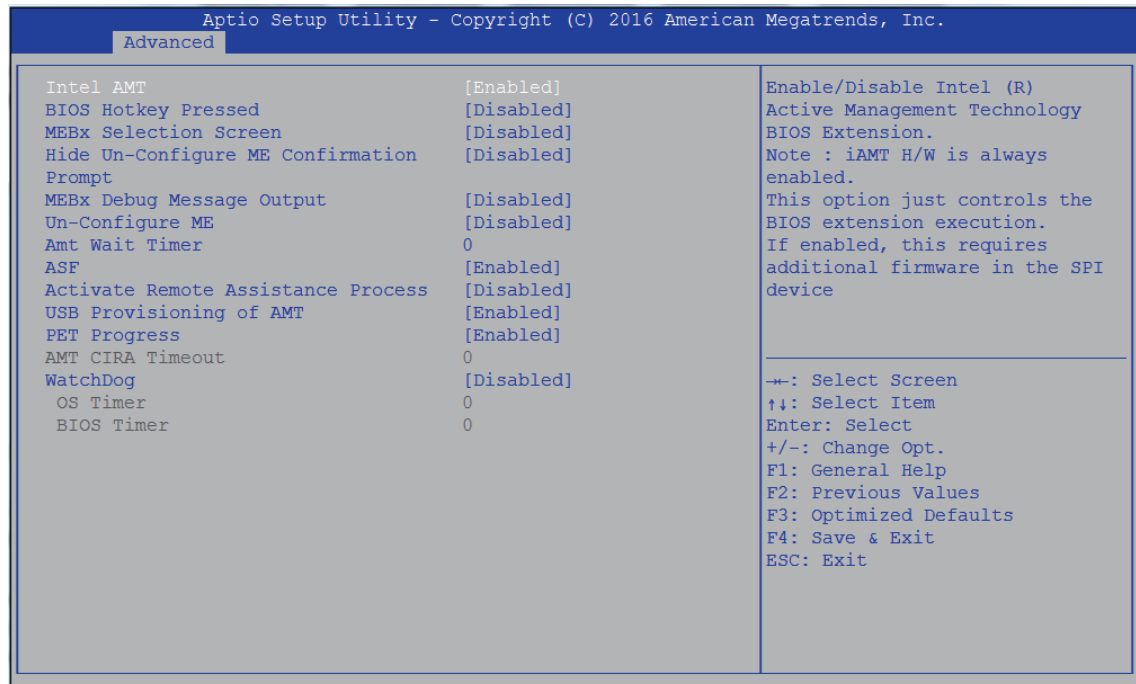

Figure 4 3-3: Intel AMT Settings

Intel AMT

Enables/disables Intel (R) Active Management Technology BIOS extension.

Note: iAMT H/W is always enabled. This option just controls the BIOS extension execution. If enabled, this requires additional firmware in the SPI device.

4.3.4 PCH-FW Configuration

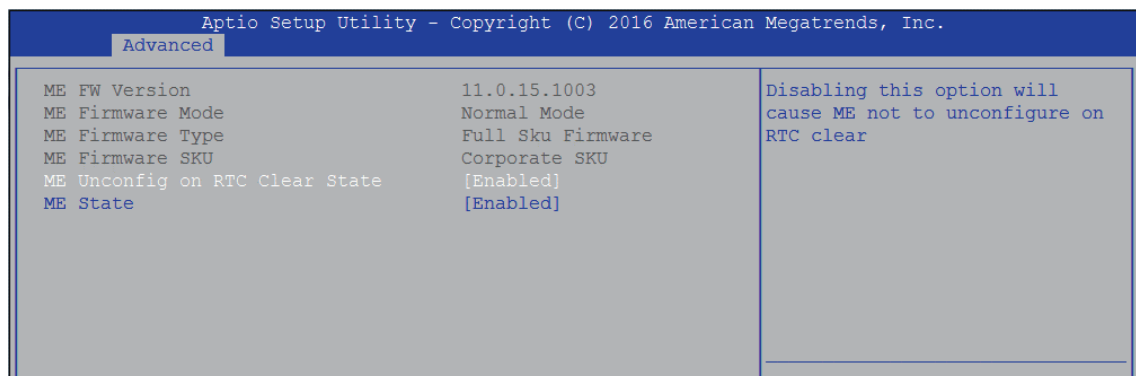

Figure 4 3-4: PCH-FW Settings

ME Unconfig on RTC Clear State

Disabling this option will cause ME not to unconfigure on RTC clear.

ME State

Set ME to Soft temporarily disabled.

4.3.5 SMART Settings

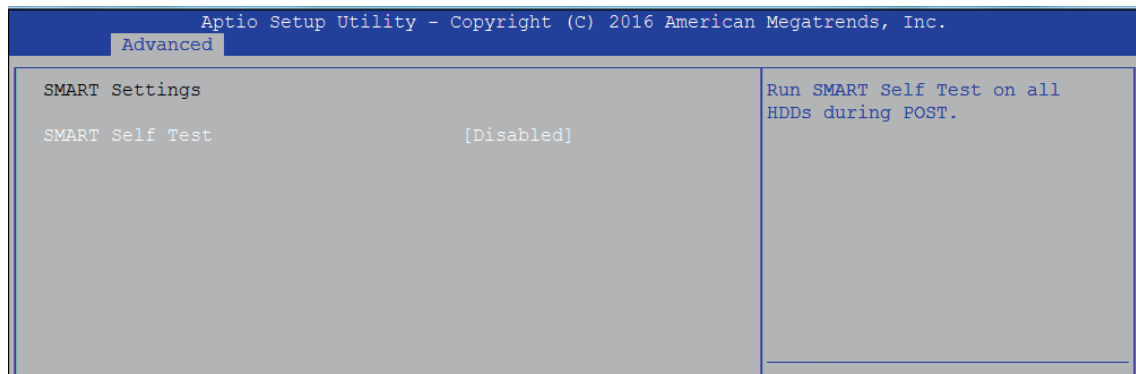

Figure 4 3-5: SMART Settings

SMART Self Test

Run SMART self test on all HDD's during POST.

4.3.6 IT8786 Super IO Configuration

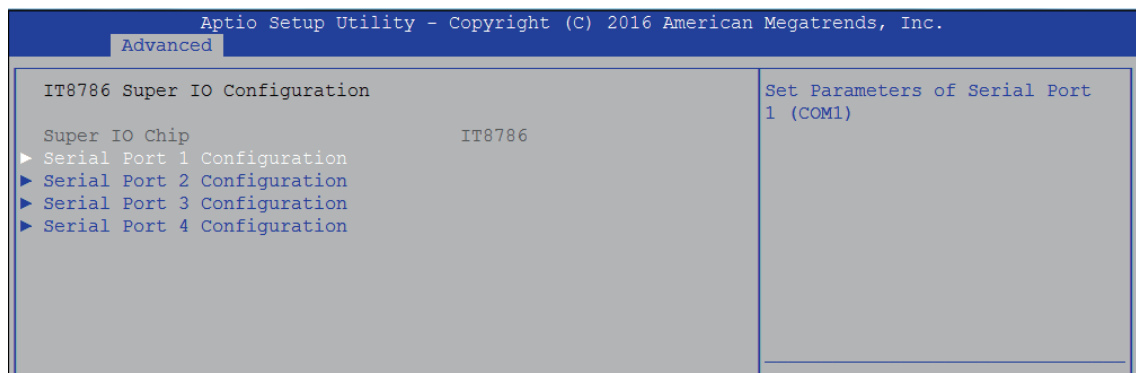

Figure 4-3-6: Super IO Settings

Serial Port 1 Configuration

Set parameters of serial port 1 (COM1).

Serial Port 2 Configuration

Set parameters of serial port 2 (COM2).

Serial Port 3 Configuration (NOT for LIGHT version)

Set parameters of serial port 3 (COM3).

Serial Port 4 Configuration (NOT for LIGHT version)

Set parameters of serial port 4 (COM4).

4.3.7 Hardware Monitor

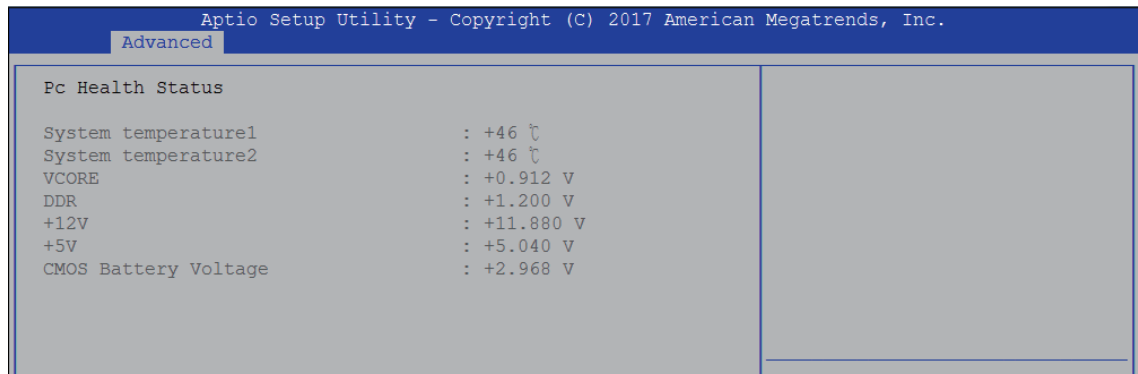

Figure 4 3-7: Hardware Monitor Settings

The IT8786 SIO features an enhanced hardware monitor providing thermal, fan speed, and system voltages' status monitoring.

4.3.8 Serial Port Console Redirection

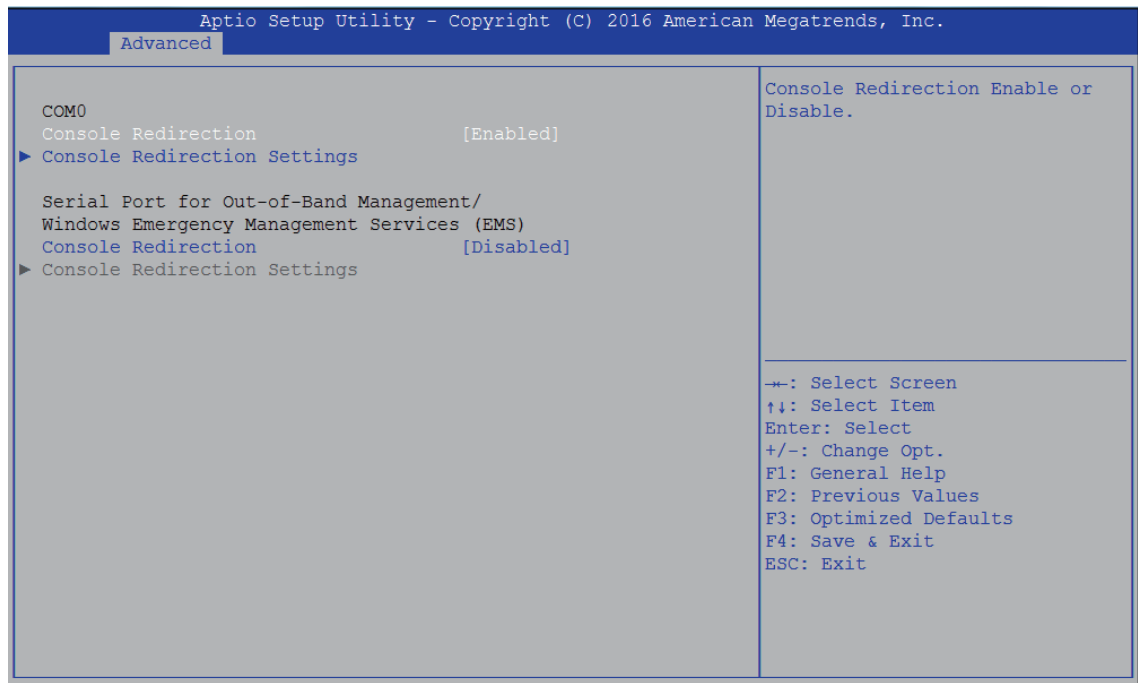

Figure 4 3-8: Serial Port Console Redirection Settings

Console Redirection

Console redirection enable or disable.

Console Redirection Settings

These settings specify how the host computer and the remote computer (which the user is using) will exchange data. Both computers should have the same or compatible settings.

4.3.9 CPU Configuration

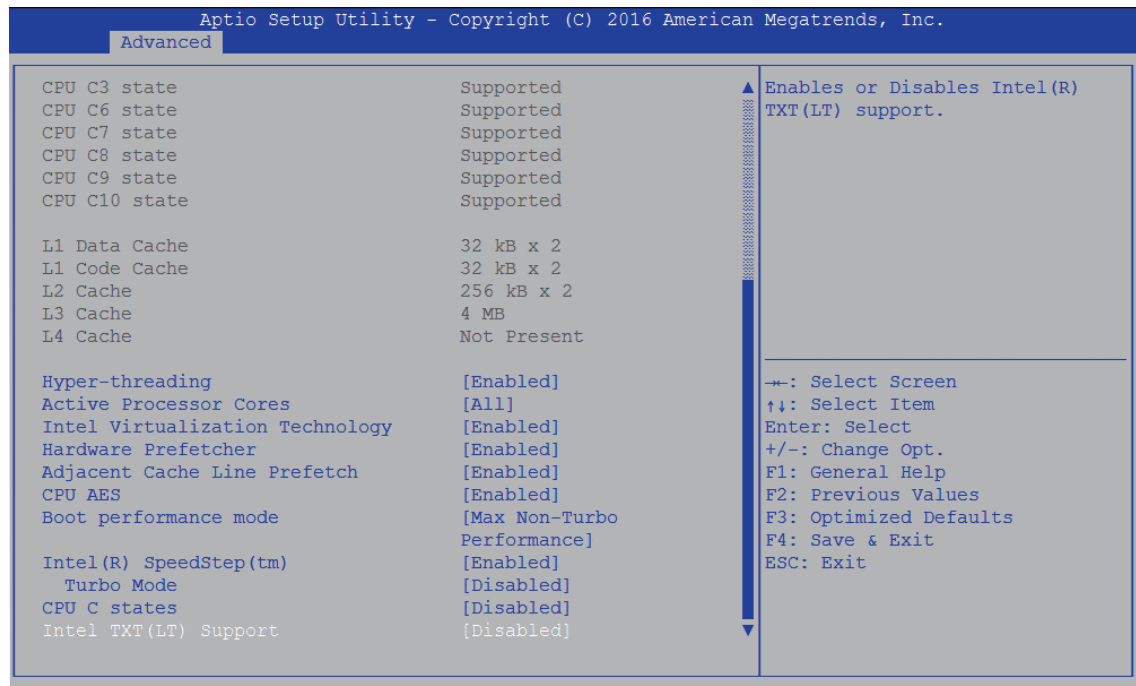

Figure 4 3-9: CPU Function Settings

Hyper-threading

Enabled for Windows XP and Linux (OS optimized for Hyper-Threading Technology) and disabled for other OS (OS not optimized for Hyper-Threading Technology). When disabled, only one thread per core is enabled.

Active Processor Cores

Number of cores to enable in each processor package.

Intel Virtualization Technology

When enabled, a VMM can utilize the additional hardware capabilities provided by Vanderpool Technology.

Hardware Prefetcher

To turn on/off the MLC streamer prefetcher.

Adjacent Cache Line Prefetch

To turn on/off prefetching of adjacent cache lines.

CPU AES

Enable/disable CPU Advanced Encryption Standard instructions.

Boot performance mode

Select the performance state that the BIOS will set before OS handoff.

Intel(R) SpeedStep(tm)

Allows more than two frequency ranges to be supported.

Turbo Mode

Turbo Mode.

CPU C state

Enable or disable CPU C states.

Enhanced C-states

Enable/disable C1E. When enabled, CPU will switch to minimum speed when all cores enter C-State.

Package C State limit

Package C State limit.

Intel TXT(LT) Support

Enables or disables Intel (R) TXT (LT) support.

4.3.10 Intel TXT Information

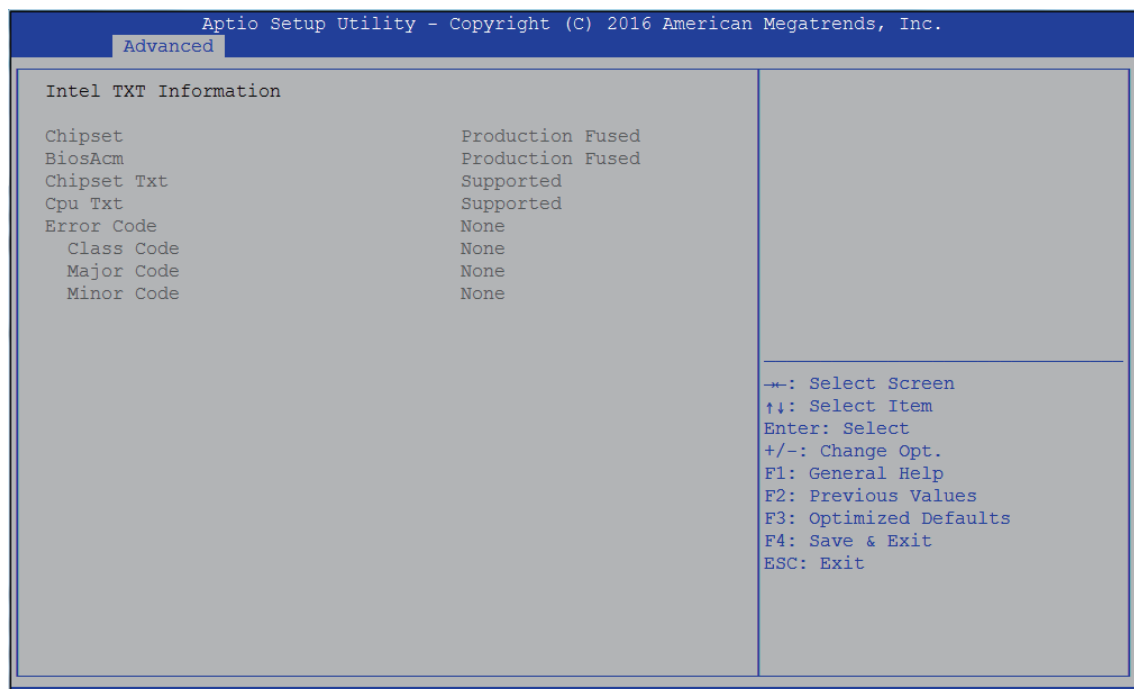

Figure 4 3-10: Intel TXT Information

Display Intel TXT information.

4.3.11 SATA Configuration

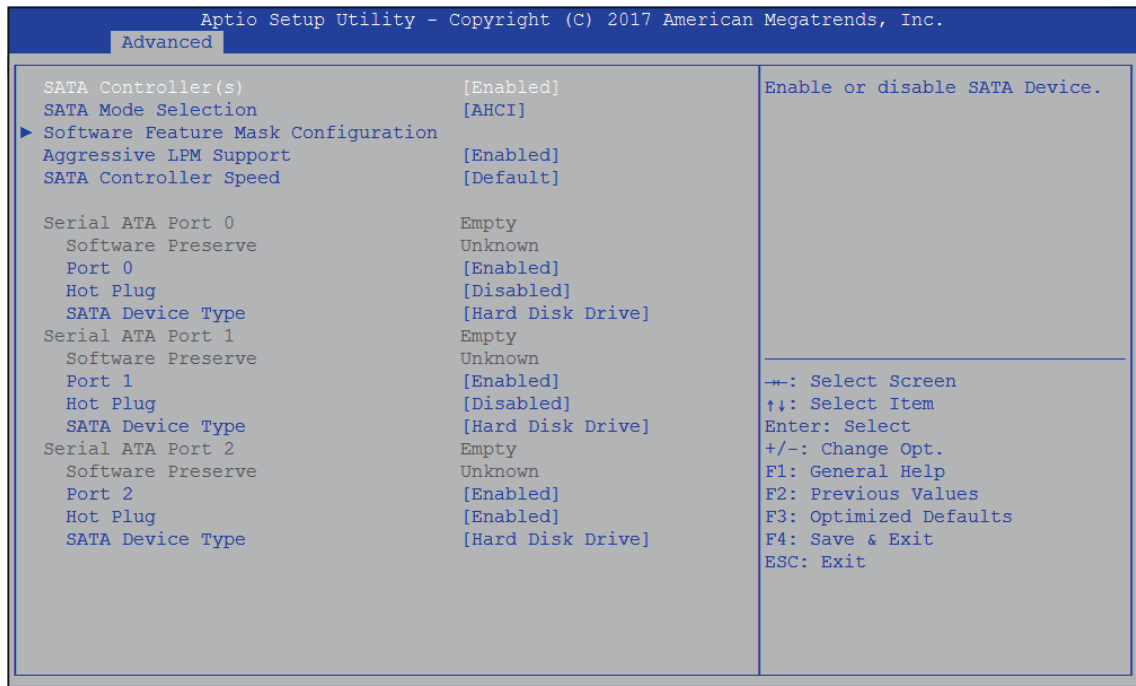

Figure 4 3-11: SATA Devices Settings

SATA Controller(s)

Enable or disable SATA Device.

SATA Mode Selection

Determines how SATA controller(s) operate.

Software Feature Mask Configuration

RAID OROM/RST driver will refer to the SWFM configuration to enable or disable the storage features.

Aggressive LPM Support

Enable PCH to aggressively enter link power state.

SATA Controller Speed

Indicates the maximum speed the SATA controller can support.

Options for each SATA port

Port 0

Enable or disable SATA Port.

SATA Device Type

Identifies that the SATA port is connected to solid state drive or hard disk drive.

4.3.12 Acoustic Management Configuration

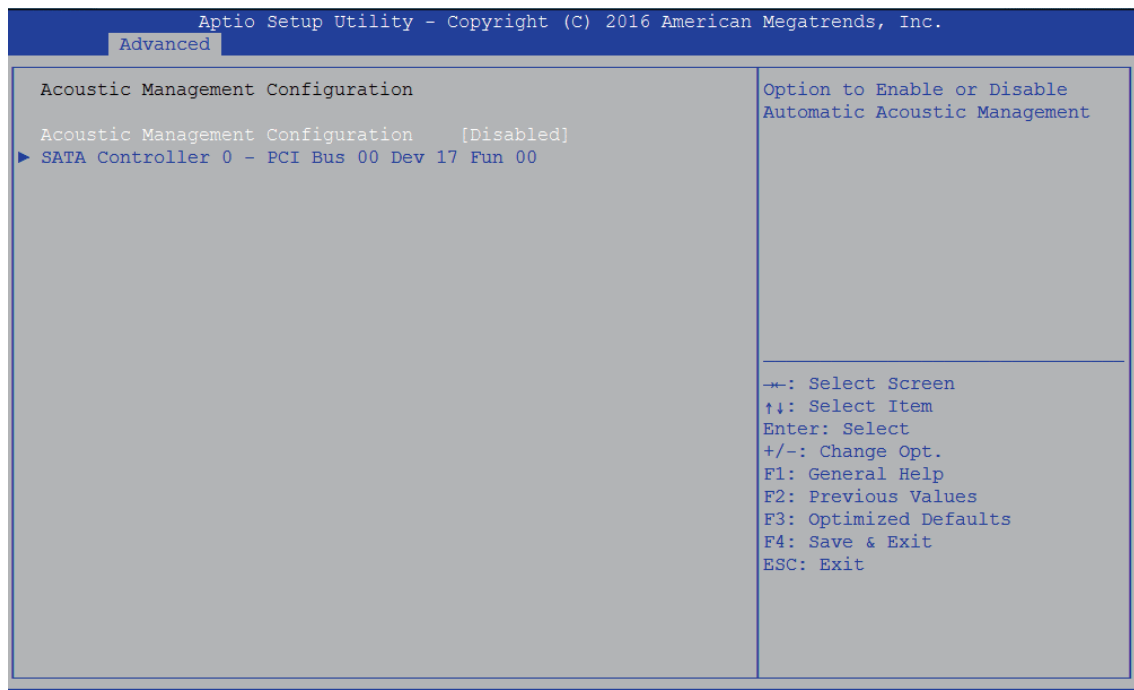

Figure 4 3-12: Acoustic Management Settings

Acoustic Management Configuration

Option to enable or disable automatic acoustic management.

4.3.13 CSM Configuration

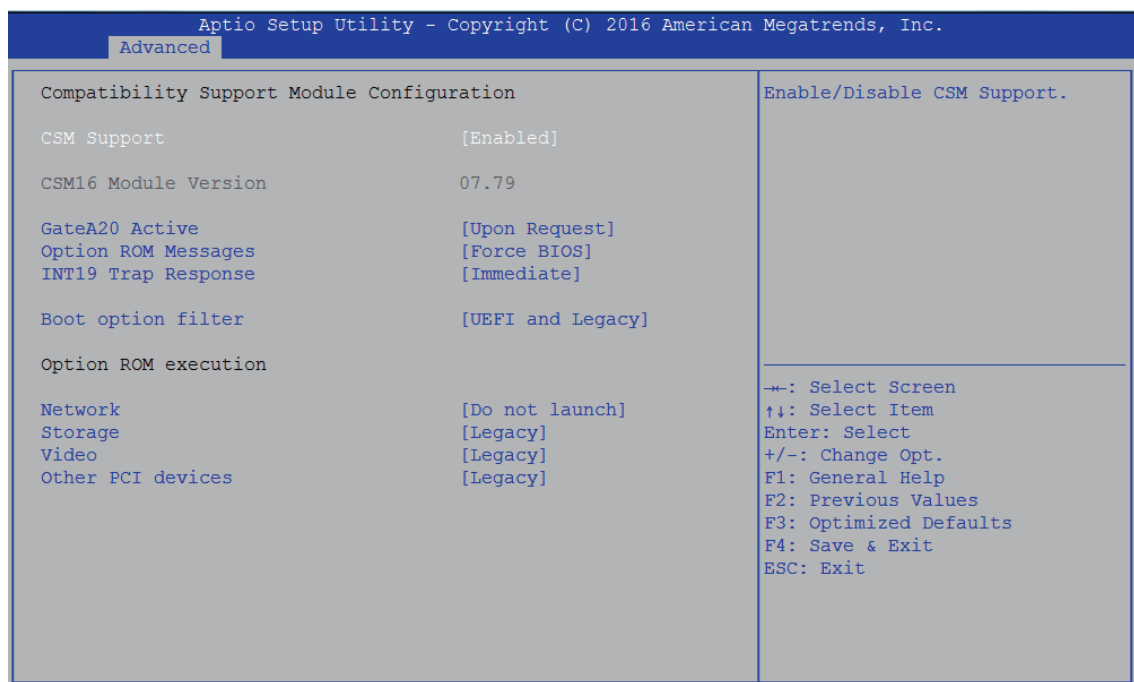

Figure 4 3-13: CSM Settings

CSM Support

Enable/disable CSM support

GateA20 Active

UPON REQUEST - GA20 can be disabled using BIOS services.

ALWAYS - do not allow GA20 to be disabled; this option is useful when any RT code is executed above 1MB.

Option ROM Messages

Set display mode for Option ROM.

INT19 Trap Response

BIOS reaction on INT19 trapping by Option ROM:

IMMEDIATE - execute the trap right away;

POSTPONED - execute the trap during legacy boot.

Boot option filter

This option controls Legacy/UEFI ROM's priority.

Network

Controls the execution of UEFI and Legacy PXE OpROM.

Storage

Controls the execution of UEFI and Legacy Storage OpROM.

Video

Allows more than two frequency ranges to be supported.

Other PCI devices

Determines OpROM execution policy for devices other than network, storage, or video.

4.3.14 USB Configuration

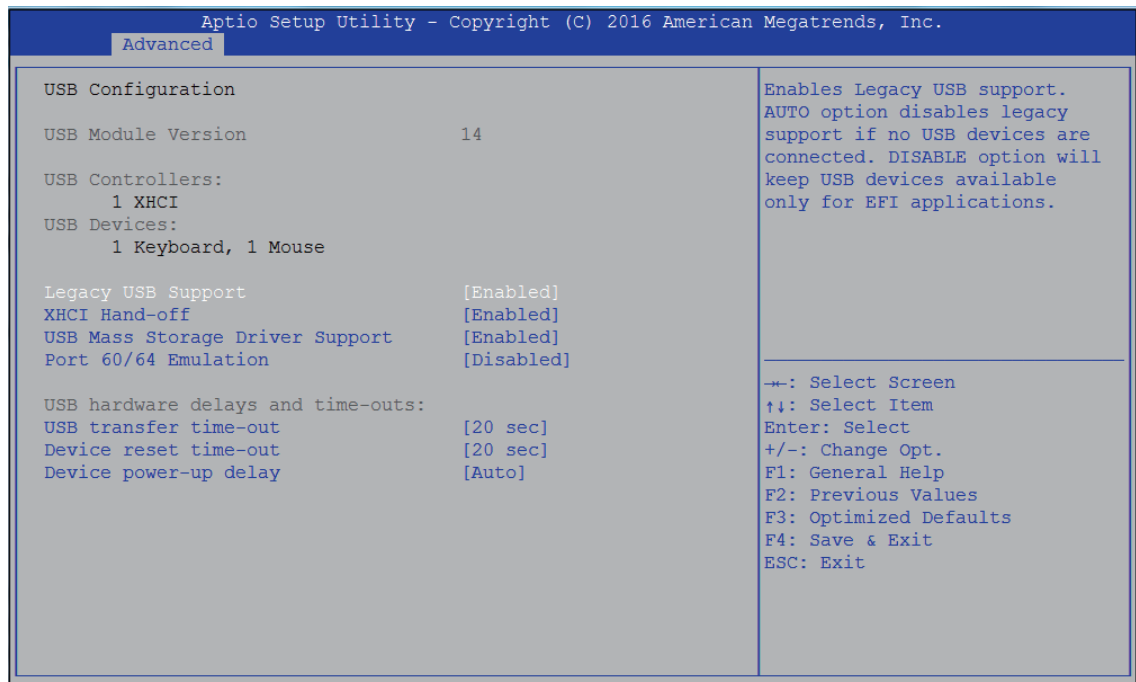

Figure 4 3-14: USB Settings

Legacy USB Support

Enables Legacy USB support.

AUTO option disables Legacy support if no USB devices are connected. DISABLE option will keep USB devices available only for EFI applications.

XHCI Hand-off

This is a workaround for OS-es without XHCI hand-off support. The XHCI ownership change should be claimed by XHCI driver.

USB Mass Storage Driver Support

Enable/disable USB mass storage driver support.

Port 60/64 Emulation

Enables I/O port 60h/64h emulation support. This should be enabled for the complete USB keyboard legacy support for non-USB aware OS-es.

USB transfer time-out

The time-out value for control, bulk, and interrupt transfers.

Device reset time-out

USB mass storage device start unit command time-out.

Device power-up delay

Maximum time the device will take before it properly reports itself to the Host Controller. 'Auto' uses default value, for a root port it is 100 ms, for a hub port the delay is taken from the hub descriptor.

4.4 Chipset

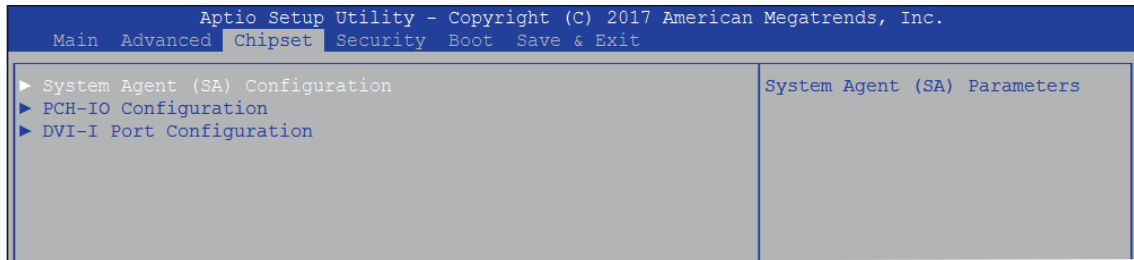

Figure 4-4: BIOS Chipset Menu

System Agent (SA) Configuration

System Agent (SA) parameters.

PCH-IO Configuration

PCH parameters.

DVI-I Port Configuration

VGA/DVI ports DDC selection.

4.4.1 System Agent (SA) Configuration

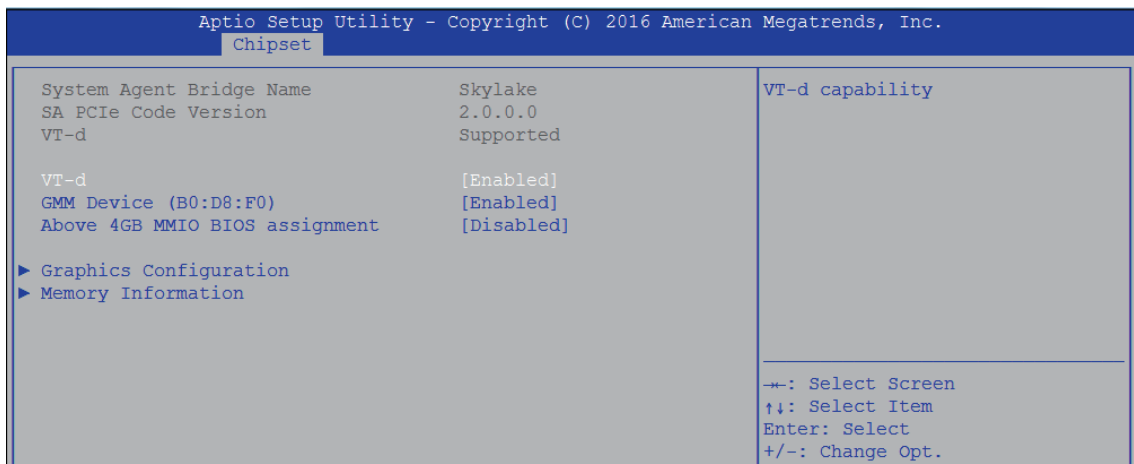

Figure 4-4-1: System Agent Settings

VT-d

VT-d capability.

GMM Device (B0:D8:F0)

Enable/disable SA GMM device.

Above 4GB MMIO BIOS assignment

Enable/disable above 4GB MemoryMappedIO BIOS assignment. This is disabled automatically when aperture size is set to 2048MB.

4.4.2 Graphics Configuration

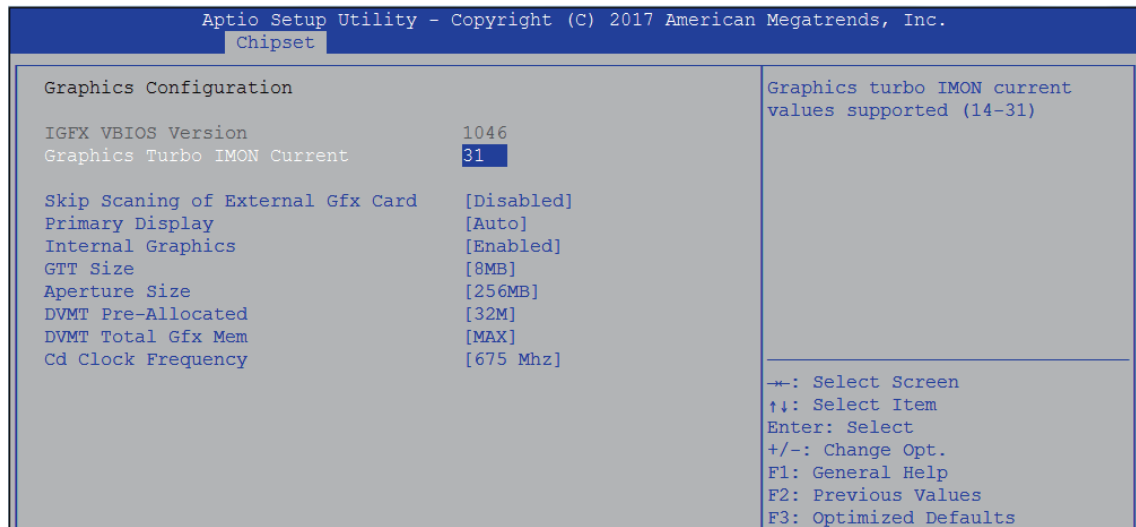

Figure 4-4-2: Graphics Settings

Skip Scanning of External Gfx Card

If Enable, it will not scan for External Gfx Card on PEG and PCH PCIE Ports.

Primary Display

Select which of IGFX/PEG Graphics device should be Primary Display.

Internal Graphics

Keep IGFX enabled based on the setup options.

GTT Size

Select the GTT Size.

Aperture Size

Select the Aperture Size.

Note: Above 4GB MMIO BIOS assignment is automatically enabled when selecting 2048MB aperture. To use this feature, please disable CSM Support.

DVMT Pre-Allocated

Select DVMT 5.0 pre-allocated (fixed) graphics memory size used by the internal graphics device.

DVMT Total Gfx Mem

Select DVMT5.0 Total Graphic Memory size used by the Internal Graphics Device.

Cd Clock Frequency

Select the highest Cd Clock frequency supported by the platform.

4.4.3 Memory Information

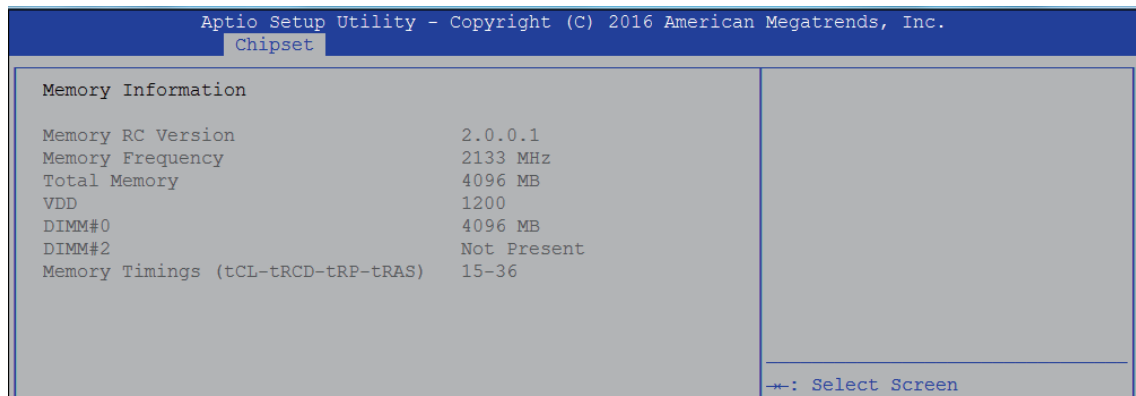

Figure 4-4-3: Memory Information

4.4.4 PCH-IO Configuration

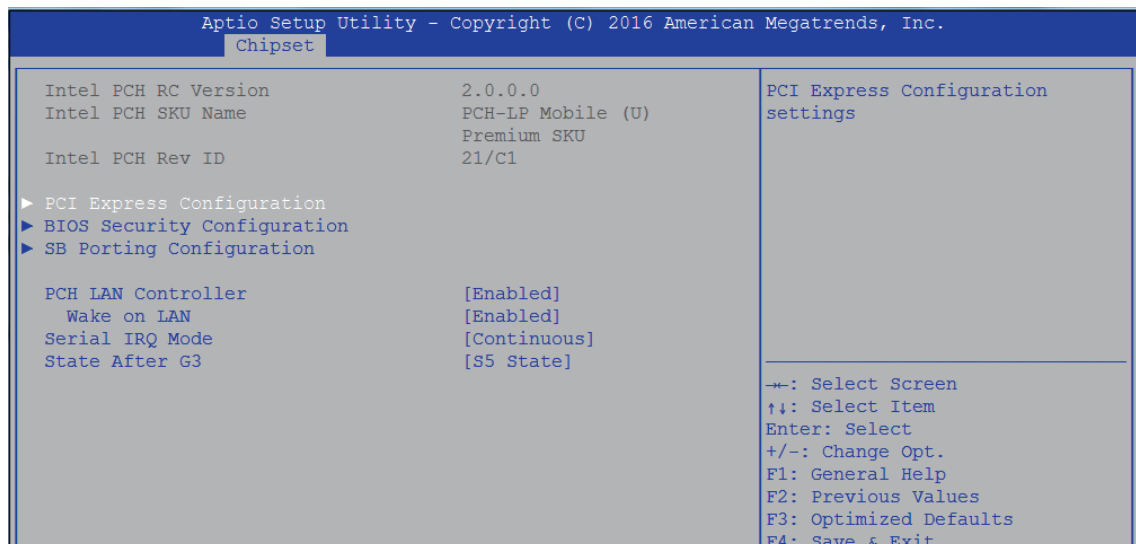

Figure 4-4-4: PCH-IO Settings

PCH LAN Controller

Enable or disable onboard NIC.

Wake on LAN

Enable or disable integrated LAN to wake the system. (The wake On LAN cannot be disabled if ME is on at Sx state.)

Serial IRQ Mode

Configure serial IRQ mode.

State After G3

Specify what state to go to when power is re-applied after a power failure (G3 state).

S0 State: Always turn-on the system when power source plugged-in.

S5 State: Always turn-off the system when power source plugged-in.

4.4.5 PCI Express Configuration

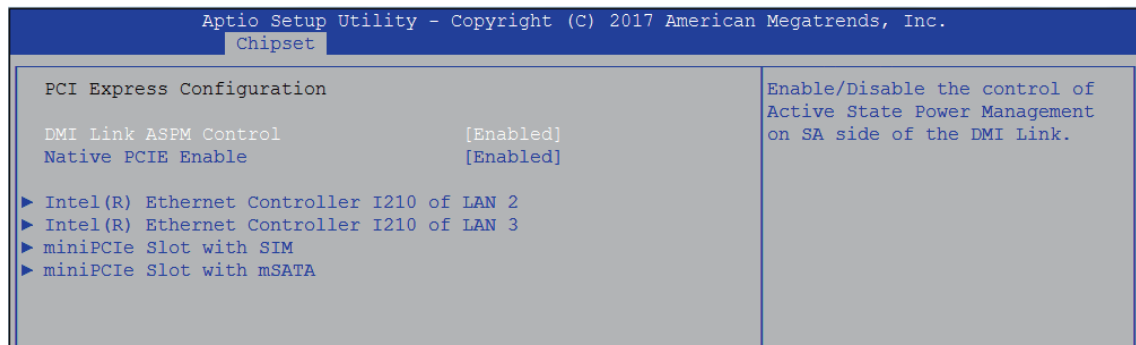

Figure 4-4-5: PCH-IO Settings

DMI Link ASPM Control

Enable/disable the control of active state power management on SA side of the DMI link.

Native PCIe Enable

PCI Express Native Support Enable/Disable. This feature is available in vista and beyond Windows OS.

Intel(R) Ethernet Controller I210 of LAN 2

Enable or disable Intel(R) Ethernet Controller I210.

Intel(R) Ethernet Controller I210 of LAN 3

Enable or disable Intel(R) Ethernet Controller I210.

miniPCIe Slot with SIM

miniPCIe Slot Settings.

miniPCIe Slot with mSATA

miniPCIe Slot Settings.

4.4.6 BIOS Security Configuration

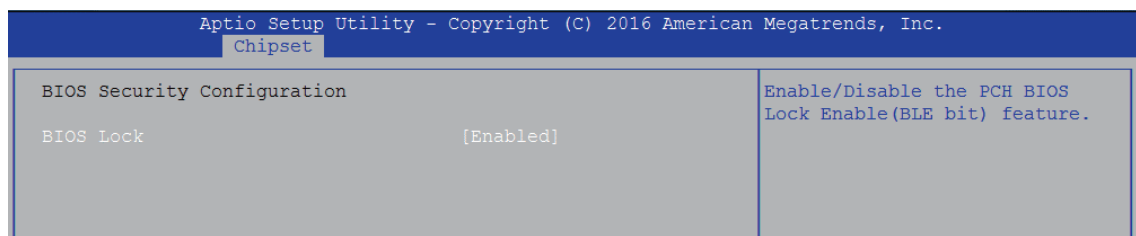

Figure 4-4-6: BIOS Security Settings

BIOS Lock

Enable/disable the PCH BIOS Lock Enable (BLE bit) feature.

4.4.7 SB Porting Configuration

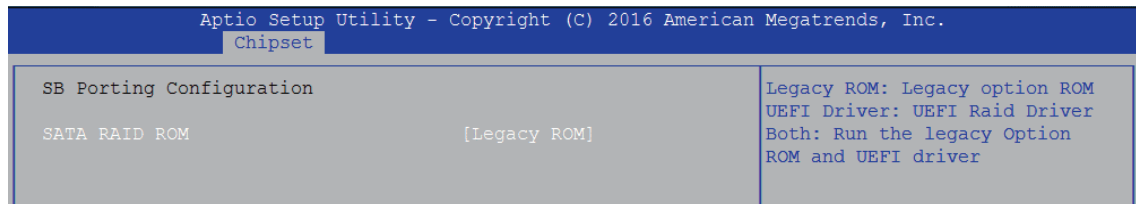

Figure 4-4-7: RAID ROM Settings

SATA RAID ROM

Legacy ROM: Legacy option ROM

UEFI Driver: UEFI Raid Driver

Both: Run the Legacy Option ROM and UEFI driver.

4.4.8 DVI-I Port Configuration

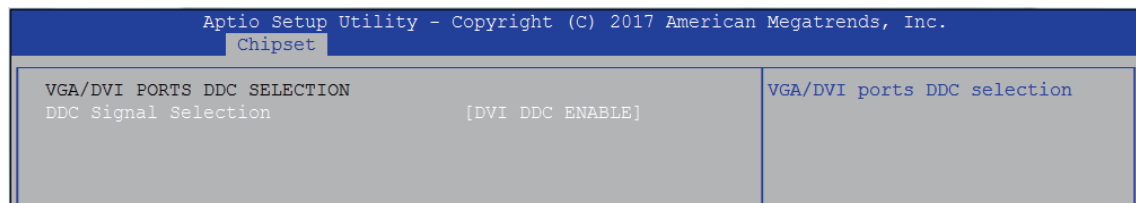

Figure 4-4-8: DVI-I DDC settings

DDC Signal Selection

VGA/DVI ports DDC selection.

4.5 Security

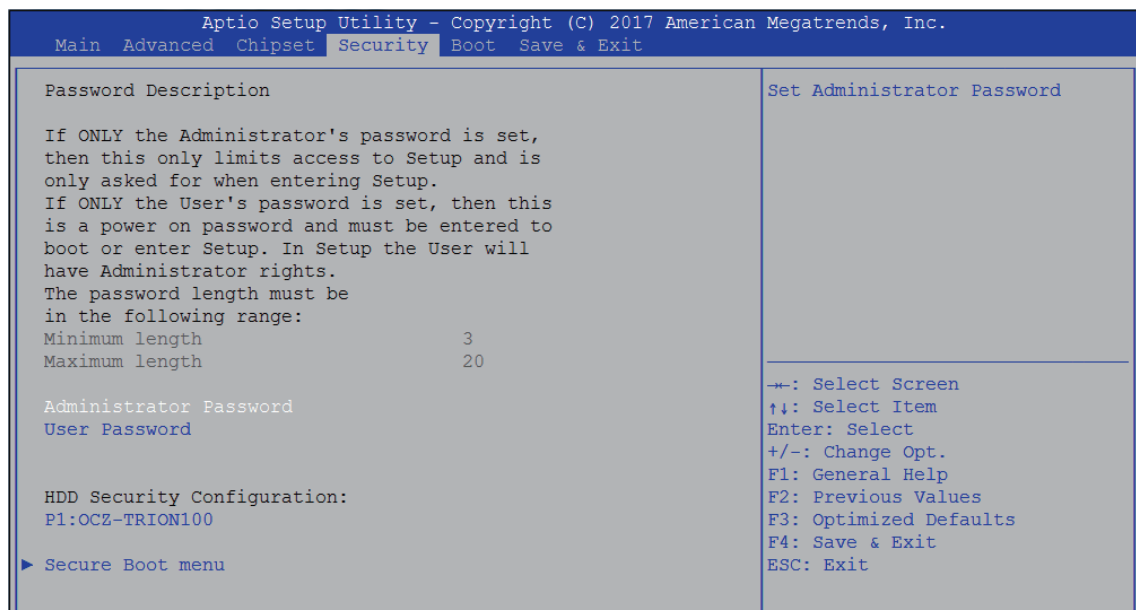

Figure 4-5: BIOS Security Settings

Administrator Password

Set administrator password.

User Password

Set user password.

4.5.1 HDD Security Configuration

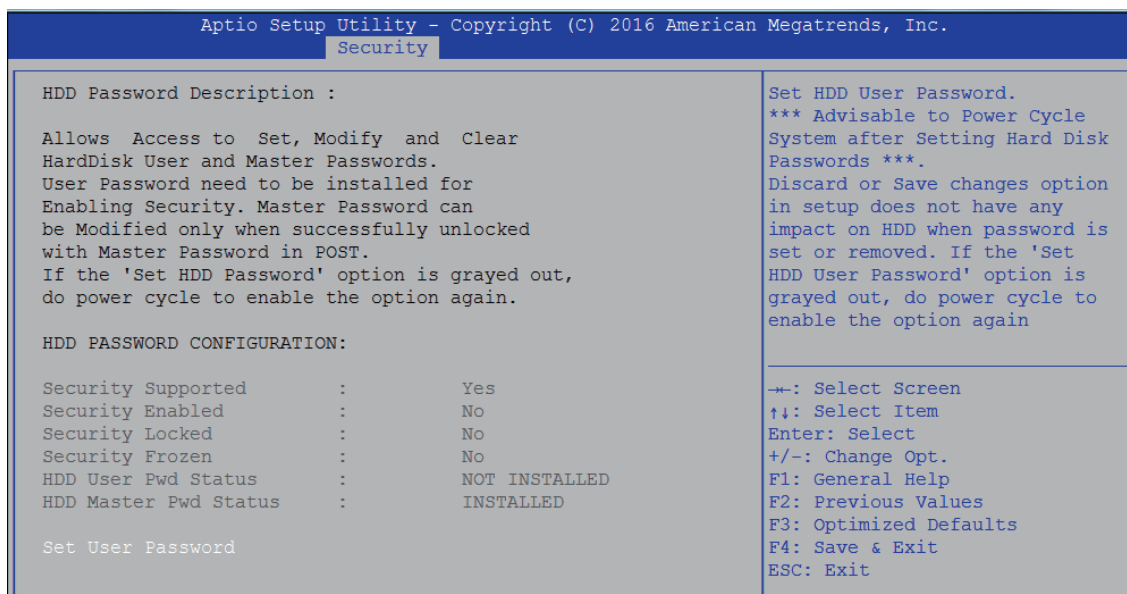

Figure 4-5-1: HDD Security Settings

Set User Password

Set HDD user password.

*** Advisable to power cycle system after setting hard disk passwords ***.

Discard or save changes option in setup does not have any impact on HDD when password is set or removed. If the 'Set HDD User Password' option is gray, do power cycle to enable the option again.

4.5.2 Secure Boot menu

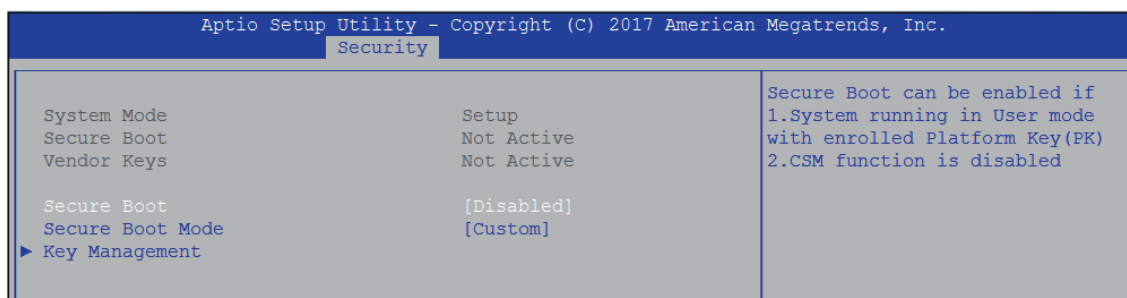

Figure 4-5-2: Secure Boot settings

Secure Boot

Secure Boot can be enabled if system is in 1. System running in User mode with enrolled Platform Key(PK) 2. CSM function is disabled

4.6 Boot

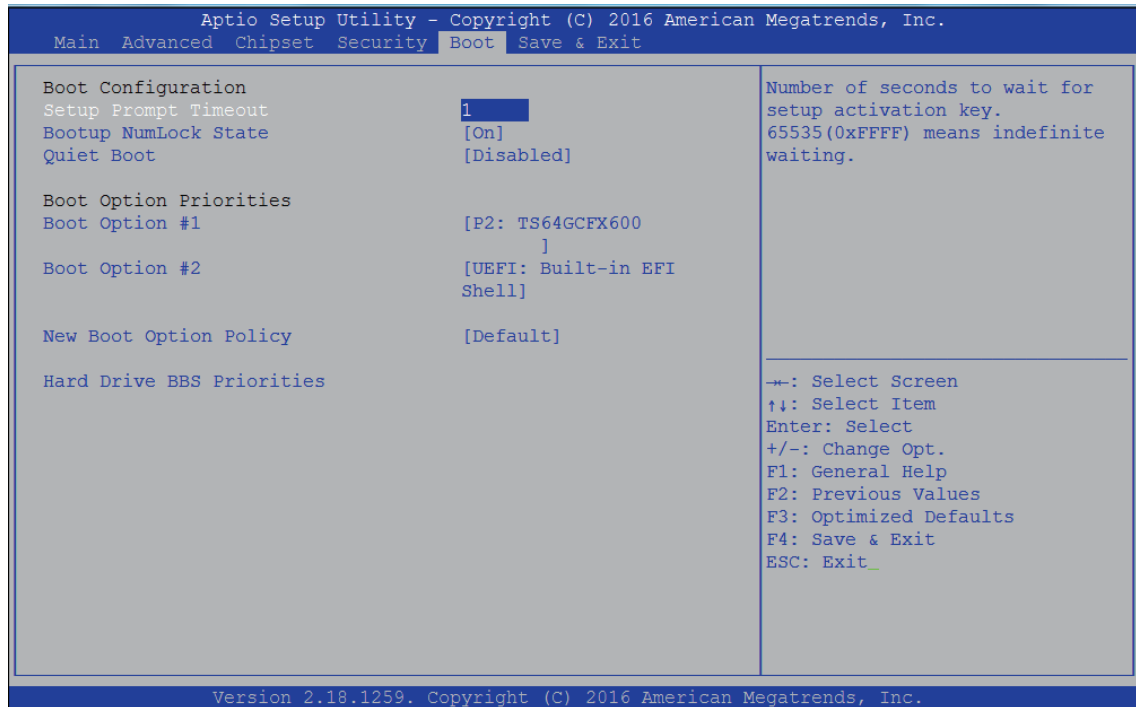

Figure 4-6: BIOS Boot Menu

Setup Prompt Timeout

Number of seconds to wait for setup activation key. 65535(0xFFFF) means indefinite waiting.

Bootup NumLock State

Select the keyboard NumLock state.

Quiet Boot

Enables or disables Quiet Boot option.

Boot Option #x

Sets the system boot order.

New Boot Option Policy

Controls the placement of newly detected UEFI boot options.

Hard Drive BBS Priorities

Set the order of the Legacy devices in this group.

4.7 Save & Exit



Figure 4-7: Save & Exit Menu

Save Changes and Exit

Exit system setup after saving the changes.

Discard Changes and Exit

Exit system setup without saving any changes.

Save Changes and Reset

Reset the system after saving the changes.

Discard Changes and Reset

Reset system setup without saving any changes.

Save Changes

Save changes done so far to any of the setup options.

Discard Changes

Discard changes done so far to any of the setup options.

Default Options:

Restore Defaults

Restore/load default values for all the setup options.

Save as User Defaults

Save the changes done so far as user defaults.

Restore User Defaults

Restore the user defaults to all the setup options.

A

APPENDIX A : Isolated DIO Guide

A.1 Function Description

The ARS-2000 offers two 16-bit (Isolated/Non-Isolated) 20-pin terminal block connector, a watchdog timer, and a 2-port POE. Isolated DIO pins are fixed by hardware design that cannot change in/out direction in runtime process. DIO definition is shown below:

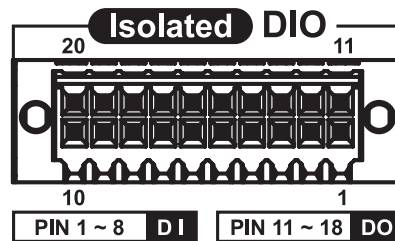

Pin No.	Isolated DIO Definition	Non-Isolated DIO Definition	Pin No.	Isolated DIO Definition	Non-Isolated DIO Definition
1	DI 0	DIO 0	11	DO 0	DIO 8
2	DI 1	DIO 1	12	DO 1	DIO 9
3	DI 2	DIO 2	13	DO 2	DIO 10
4	DI 3	DIO 3	14	DO 3	DIO 11
5	DI 4	DIO 4	15	DO 4	DIO 12
6	DI 5	DIO 5	16	DO 5	DIO 13
7	DI 6	DIO 6	17	DO 6	DIO 14
8	DI 7	DIO 7	18	DO 7	DIO 15
9	DI_COM	NC	19	DIO_GND	DIO_GND
10	DIO_GND	DIO_GND	20	External VDC	NC

POE definition is shown below :

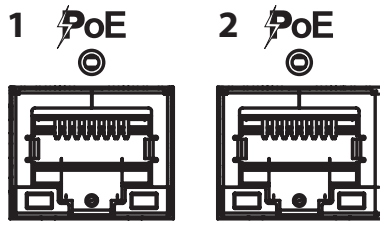

Do NOT use these functions in below:

1. PE-2000: DIO1 (ID = 0), POE
2. PE-3000: POE(ID=0)
3. UE-1000: USB (ID = 0)

Pin No.	Definition	Pin No.	Definition
1	POE 0	2	POE 1

A.2 Isolated DIO Signal Circuit

DI reference circuit:

Sink Mode (NPN)

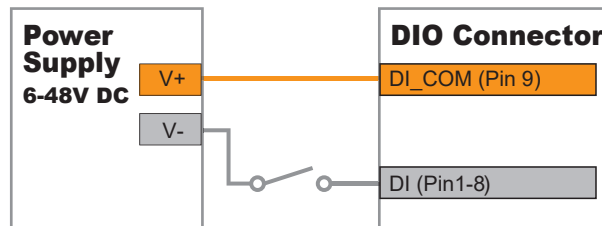

Source Mode (PNP)

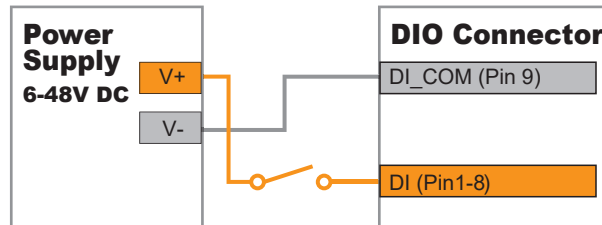

DO reference circuit:

Sink Mode
(NPN, Default)

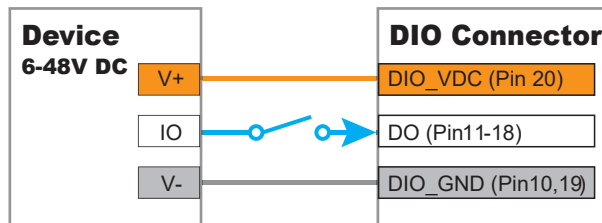

Source Mode
(PNP)

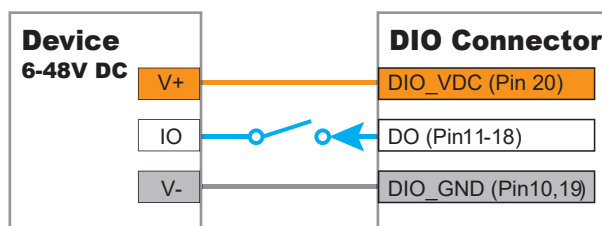

A.3 Isolated DIO Signal Circuit

Distribution folder include x32 and x64 versions, use batch file for installation.

There are included as followed:

Win7_32.bat:

Installation for 32-bit driver

Win7_64.bat:

Windows update package which driver required (need to restart), and

Installation for 64-bit driver

Win8_32.bat, Win8_64.bat:

Installation for driver, and

guideline to Framework 3.5 distribution for sample

Win10_32.bat, and Win10_64.bat

Installation for driver, and

installation to Framework 3.5 distribution for sample

Uninstall_32.bat, and Uninstall_64.bat:

Uninstallation for driver

Run batch file as Administrator.

Support Windows 7 above.

Make sure Windows version before installation.

Runtime folder include head file for software developer or System Integration. Sample folder include sample program, driver library, and API library. Source folder include sample program source code that compile on Visual Studio 2008.

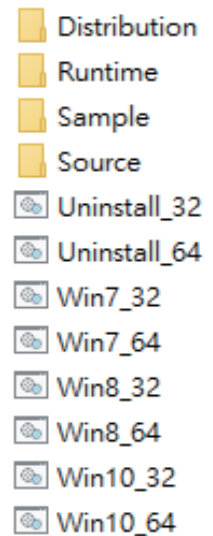

A.4 Function Description

Demo tool (ARS2K.exe)

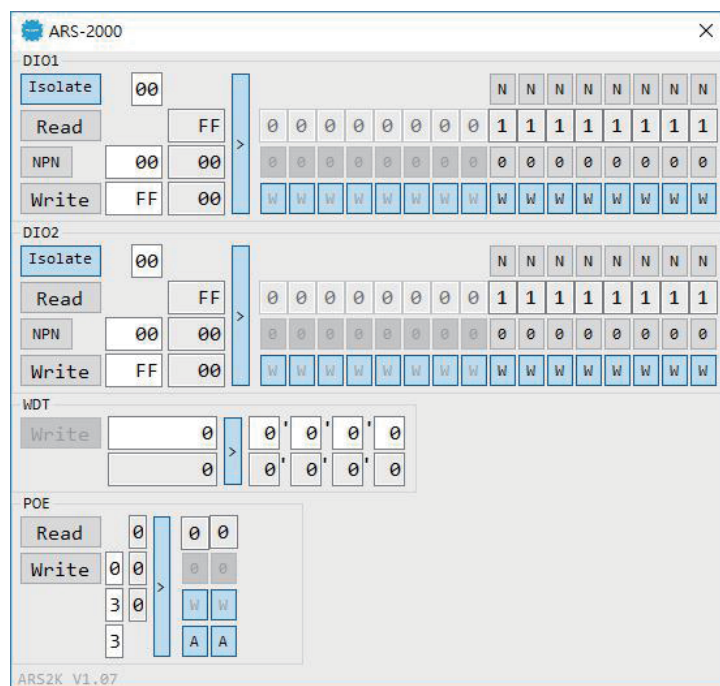
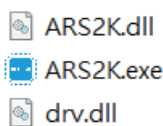

DIO1 / DIO2 group:

Isolate check button:

DIO type of DIO configuration, isolated / non-isolated.

Read button:

Set DIO configuration to get DI / DIO input state.

DO type check button:

User setting, DO type of DIO configuration to setup 8 pins - Source / Sink.

Use for Write (DO) button activate.

Write button:

Set DIO configuration to set DO / DIO output state.

DI preference text:

User setting, DI type of DIO configuration by hexadecimal bitmask

- Source / Sink.

Use for Read (DI) button activate.

DO / DIO output text:

User setting, DO / DIO output state by hexadecimal bitmask - on / off.

Use for Write button activate.

DO / DIO writable text:

User setting, DO / DIO writable of DIO configuration by hexadecimal bitmask

- yes / no.

Use for Read (DIO) / Write button activate.

DI / DIO input text (read only):

DI / DIO input state by hexadecimal bitmask – on /off.

Use for Read button activate.

DO / DIO text (read only):

DO / DIO output state with input state (DIO) and configuration.

Use for Write button activate.

DO / DIO output text (read only):

DO / DIO output state with configuration.

Use for Write button activate.

DI type pin texts (pin 8 ~ pin 1):

User setting, DI pin type of DIO configuration - Source / Sink.

DI / DIO input pin texts (read only, pin 8 ~ pin 1 / pin 18 ~ pin 11, pin 8 ~ pin 1):

DI / DIO input pin state

Use for Read button activate.

DO / DIO output pin texts (pin 18 ~ pin 11 / pin 18 ~ pin 11, pin 8 ~ pin 1):

User setting, DO / DIO output pin state

Use for Write button activate.

DO / DIO pin writable texts (pin 18 ~ pin 11 / pin 18 ~ pin 11, pin 8 ~ pin 1):

User setting, DO / DIO pin writable of DIO configuration.

Use for Read (DIO) / Write button activate.

WDT group:

Write button:

Set WDT when WDT setup text is valid.

Stop button:

Cancel WDT and counting.

Use after Write button action.

WDT setup text:

User setting, WDT value, unit: second.

Use for Write button activate.

WDT counting text (read only):

WDT counting by program timer after set WDT.

Shown after Write button action.

WDT setup day format texts (user setting):

User setting, WDT value, format: day'hour'minute'second.

WDT counting day format text (read only):

WDT counting, format: day'hour'minute'second.

POE group:

Read button:

Set POE configuration to get POE state.

Write button:

Set POE configuration to set POE state.

POE output text:

User setting, POE output state by hexadecimal bitmask - on / off.

Use for Write button activate.

POE writable text:

User setting, POE writable of POE configuration by hexadecimal bitmask
- yes / no.

Use for Write button activate.

POE mode text:

User setting, POE mode of POE configuration by hexadecimal bitmask
- Auto / Manual.

Use for Write button activate.

POE input text (read only):

POE input state by hexadecimal bitmask - on / off.

Use for Read button activate.

POE text (read only):

POE output state with input state and configuration.

Use for Write button activate.

POE output text (read only):

POE output state with configuration.

Use for Write button activate.

POE input port texts (read only, port 2 ~ port 1):

POE input port state

Use for Read button activate.

POE output port texts (port 2 ~ port 1):

User setting, POE output port state

Use for Write button activate.

POE port writable texts (port 2 ~ port 1):

User setting, POE port writable of POE configuration.

Use for Write button activate.

POE port mode texts (port 2 ~ port 1):

User setting, POE port mode of POE configuration.

Use for Write button activate.

B

APPENDIX B : Software Functions

B.1 Driver API Guide

In Runtime folder, on ARS2K.h :

`_DLL_IMPORT_` definition is used on LoadLibrary API for ARS2K.dll.

`ARS2K_EXPORTS` definition is used on ARS2K.dll building.

Otherwise, that is used to compile with ARS2K.lib

BOOL Initial (BYTE Isolate_Type, BYTE DIO_NPN)

Initial machine for DIO, watchdog timer, and POE

Isolate_Type: DIO type

1: Isolated DIO;

0: Non-Isolated DIO

DIO_NPN: DI / DO type

1: PNP (Source) mode for European rule;

0: NPN (Sink) mode for Japanese rule

Return:

TRUE (1): Success;

FALSE (0): Fail (Driver not exists, or initial error (version is too old, or machine not match))

BOOL GetDIO1Config(BYTE *Isolate_Type, BYTE *DI_NPN, BYTE *DO_NPN, WORD *Mask)

BOOL GetDIO2Config(BYTE *Isolate_Type, BYTE *DI_NPN, BYTE *DO_NPN, WORD *Mask)

Get DIO configuration (by variable)

Isolate_Type: DIO type

1: Isolated DIO;

0: Non-Isolated DIO

DI_NPN ([7:0]): DI type, pin setting by hexadecimal bitmask

1: PNP (Source) mode for European rule;

0: NPN (Sink) mode for Japanese rule

DO_NPN: DO type

1: PNP (Source) mode for European rule;

0: NPN (Sink) mode for Japanese rule

Mask ([15:0]): In / Out, pin setting by hexadecimal bitmask

1: Output;

0: Input

Return:

TRUE (1): Success;

FALSE (0): Fail (Initial error, or call by pointer error, or hardware problem)

BOOL SetDIO1Config(BYTE *Isolate_Type, BYTE *DI_NPN, BYTE *DO_NPN, WORD *Mask)

BOOL SetDIO2Config(BYTE *Isolate_Type, BYTE *DI_NPN, BYTE *DO_NPN, WORD *Mask)

Set DIO configuration

Isolate_Type: DIO type

1: Isolated DIO;

0: Non-Isolated DIO

DI_NPN ([7:0]): DI type, pin setting by hexadecimal bitmask

1: PNP (Source) mode for European rule;

0: NPN (Sink) mode for Japanese rule

DO_NPN: DO type

1: PNP (Source) mode for European rule;

0: NPN (Sink) mode for Japanese rule

Mask ([15:0]): In / Out, pin setting by hexadecimal bitmask

1: Output;

0: Input

Return:

TRUE (1): Success;

FALSE (0): Fail (Initial error, or hardware problem)

BOOL GetDI1(BYTE *DI)

BOOL GetDI2(BYTE *DI)

Get isolated DIO input (DI)

DI ([7:0]): Input state, pin setting by hexadecimal bitmask

1: High;

0: Low

Return:

TRUE (1): Success;

FALSE (0): Fail (Initial error, or call by pointer error, or hardware problem)

BOOL GetDO1(BYTE *DO)

BOOL GetDO2(BYTE *DO)

Get isolated DIO output (DO)

DO ([7:0]): Output state, pin setting by hexadecimal bitmask

1: High;

0: Low

Return:

TRUE (1): Success;

FALSE (0): Fail (Initial error, or call by pointer error, or hardware problem)

BOOL SetDO1(BYTE DO)

BOOL SetDO2(BYTE DO)

Set isolated DIO output (DO)

DO ([7:0]): Output state, pin setting by hexadecimal bitmask

1: High;

0: Low

Return:

TRUE (1): Success;

FALSE (0): Fail (Initial error, or hardware problem)

BOOL GetDIO1(WORD *DI)

BOOL GetDIO2(WORD *DI)

Get non-isolated DIO input (DIO input)

DI ([15:0]): Input state, pin setting by hexadecimal bitmask

1: High;

0: Low

Return:

TRUE (1): Success;

FALSE (0): Fail (Initial error, or call by pointer error, or hardware problem)

BOOL SetDIO1(WORD DO)

BOOL SetDIO2(WORD DO)

Get non-isolated DIO input (DIO input)

DI ([15:0]): Input state, pin setting by hexadecimal bitmask

1: High;

0: Low

Return:

TRUE (1): Success;

FALSE (0): Fail (Initial error, or hardware problem)

BOOL GetWDT(DWORD *WDT)

Set non-isolated DIO output (DIO output)

DO ([15:0]): output state, pin setting by hexadecimal bitmask

1: High;

0: Low

Return:

TRUE (1): Success;

FALSE (0): Fail (Initial error, or hardware problem)

BOOL SetWDT(DWORD WDT)

Set watchdog timer setup

WDT: watchdog timer setup

Unit: second. (Range: 1 ~ 65535 sec, 1093 ~ 65535 min

(=65580 ~ 3932100 sec))

Return:

TRUE (1): Success;

FALSE (0): Fail (Initial error, or setup 0 error, or hardware problem)

BOOL CancelWDT()

Cancel watchdog timer

Return:

TRUE (1): Success;

FALSE (0): Fail (Initial error, or hardware problem)

BOOL GetPOEConfig(BYTE *Auto, BYTE *Mask)

Get POE configuration (by variable)

Auto ([1:0]): Auto mode, pin setting by hexadecimal bitmask

1: Auto;

0: Manual

Mask ([1:0]): DC Enable / Disable, pin setting by hexadecimal bitmask

1: Enable;

0: Disable

Return:

TRUE (1): Success;

FALSE (0): Fail (Initial error, or call by pointer error, or hardware problem)

BOOL SetPOEConfig(BYTE Auto, BYTE Mask)

Set POE configuration

Auto ([1:0]): Auto mode, pin setting by hexadecimal bitmask

1: Auto;

0: Manual

Mask ([1:0]): DC Enable / Disable, pin setting by hexadecimal bitmask

1: Enable;

0: Disable

Return:

TRUE (1): Success;

FALSE (0): Fail (Initial error, or out of range error, or hardware problem)

BOOL GetPOE(BYTE *POE)

Get POE input

POE ([1:0]): POE state, pin setting by hexadecimal bitmask

1: On;

0: Off

Return:

TRUE (1): Success;

FALSE (0): Fail (Initial error, or call by pointer error, or hardware problem)

BOOL SetPOE(BYTE POE)

Set POE output

POE ([1:0]): POE state, pin setting by hexadecimal bitmask

1: On;

0: Off

Return:

TRUE (1): Success;

FALSE (0): Fail (Initial error, or out of range error, or hardware problem)

C

APPENDIX C : RAID Installation Guide

C.1 RAID Functions

C.1.1 SATA Mode for RAID

Please select SATA device to RAID mode on BIOS menu.

Advanced → SATA Configuration → SATA Mode Selection → RAID (Skylake platform) / Intel RST Premium (Kaby Lake platform)

Main	Advanced	Chipset	Boo	Security	Save & Exit
SATA Controller(s)				[Enabled]	Item Specific Help
SATA Model Selection				[AHCI]	

C.1.2 UEFI Mode for RAID

1. Please select SATA device to RAID mode on BIOS menu.

Advanced → SATA Configuration → SATA Mode Selection →

RAID (Skylake platform) / Intel RST Premium (Kaby Lake platform)

2. Please select Software Feature Mask Configuration on BIOS menu.

Aptio Setup Utility - Copy	
Chipset	
SATA And RST Configuration	
SATA Controller(s)	[En
SATA Mode Selection	[In
RAID Device ID	[C.
▶ Software Feature Mask Configuration	

3. Use RST Legacy → Disabled → Save Changes and Reset.

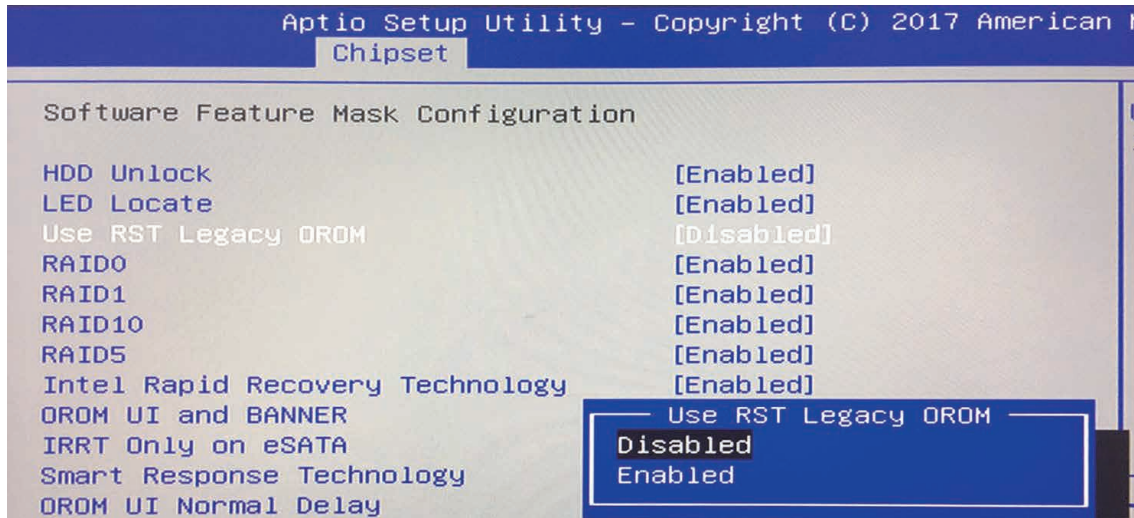

4. Into BIOS menu again, select Intel(R) Rapid Storage Technology on BIOS menu.

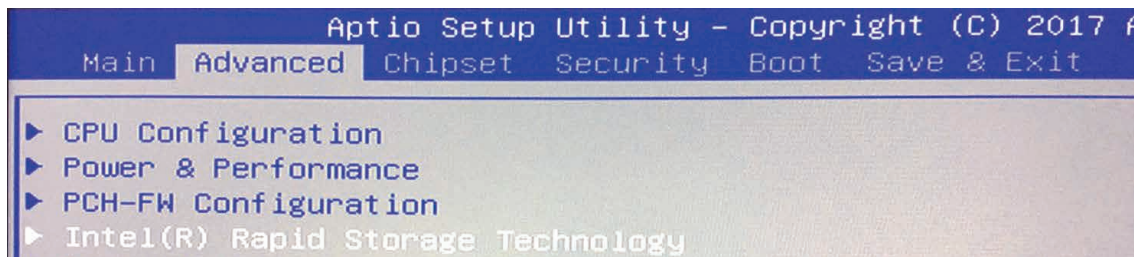

5. Select Create RAID Volume on BIOS menu.

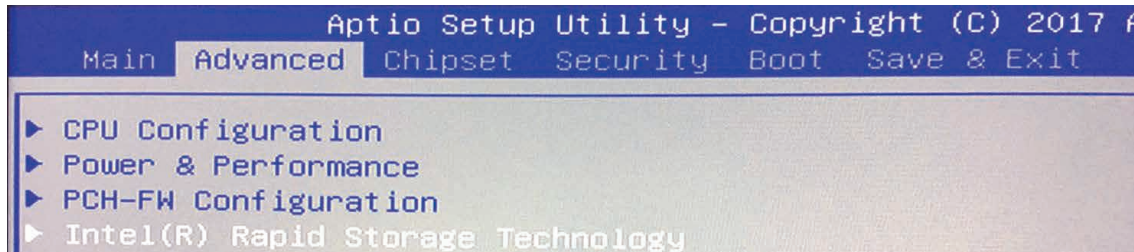

6. Select disks to create RAID Volume then Save Changes and Reset to install OS with EFI mode.

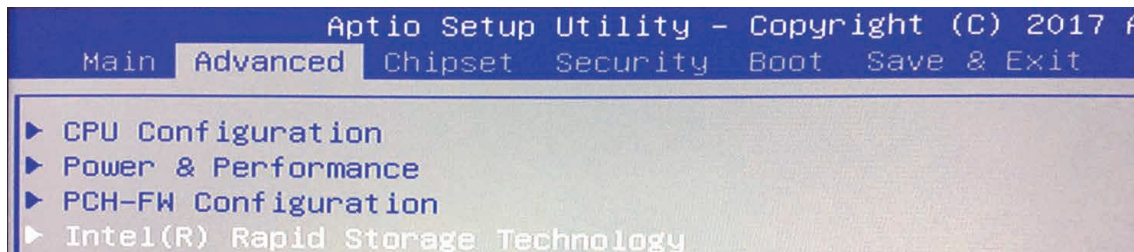

C.2 OS Installation

ARS-2000 is featured with two SATA, including two internal SATA. We used SATA for Windows 10 OS installation as an example.

C.3 Install All Device Drivers of ARS-2000 System

The instructions are as follows:

1. Install Chipset driver
2. Install Network driver
3. Install ME driver (if available)
4. Install Audio driver
5. Install VGA driver

C.4 Install “Intel Rapid Storage Technology” Software

You can get the latest information and the software directly from Intel website.

http://www.intel.com/p/en_US/support/highlights/chpsts/imsm

The RAID environment has been done if you completed the steps above.

C.5 Insert SATA HDD for RAID 1

Please note, you can use two SATA ports for SATA HDD, except for mSATA slot.

C.6 Create RAID Volume on “Rapid Storage Technology” Software

ARS-2000 is featured with two SATA HDD’s for RAID volume, so there are two options to choose on this page. Let’s take RAID 1 as an example, select “RAID 1”

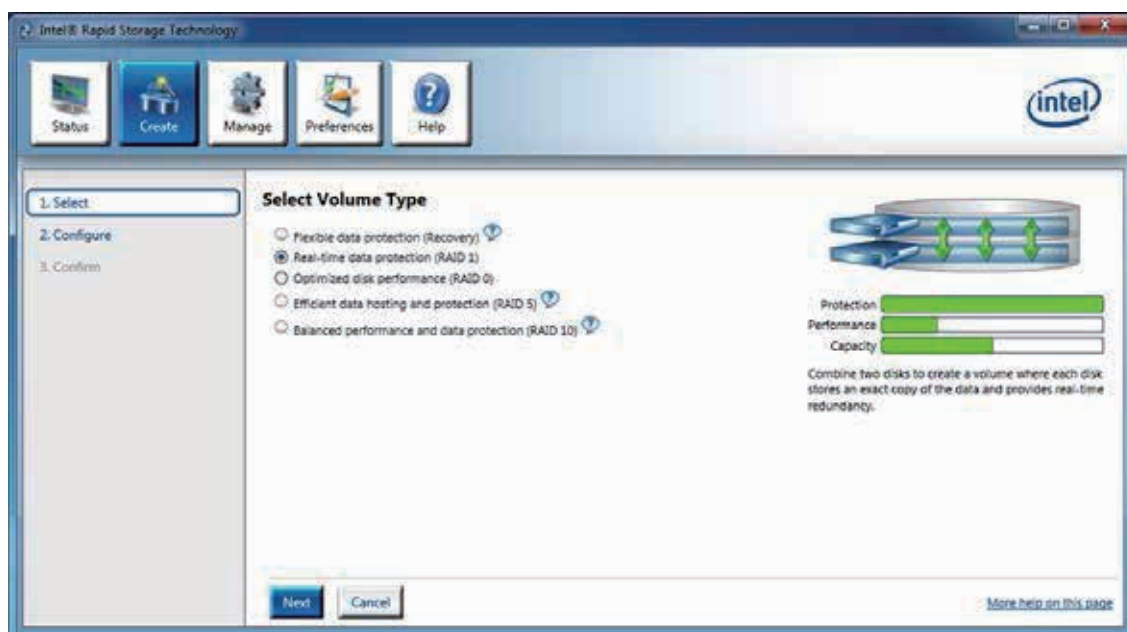

C.7 Disk Management : Partition the Disk

After RAID 1 volume created, you can see the figure of SATA device allocation.

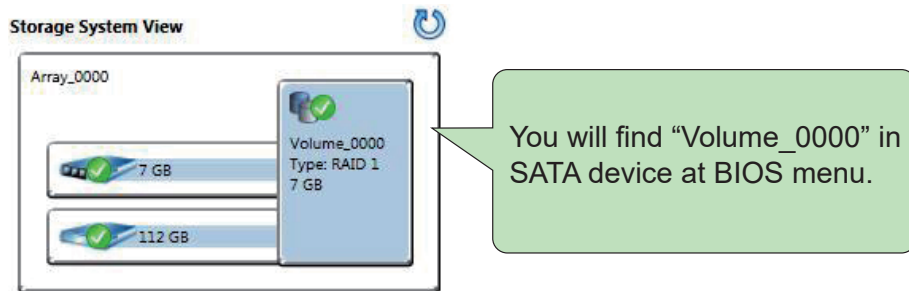

To start Disk Management tool, select "initialize disk."

Then add "Logical Device" for Windows access.

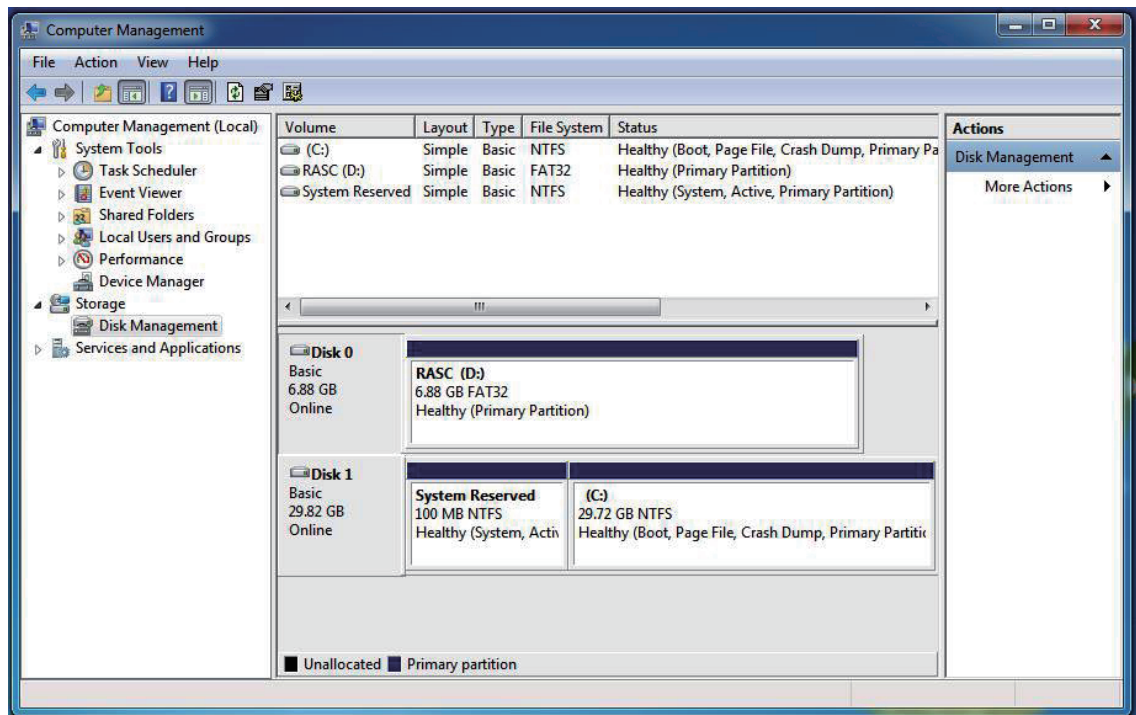

C.8 If One SATA HDD on RAID Volume is Out-of-use

After RAID 1 volume created, you can see the figure of SATA device allocation.

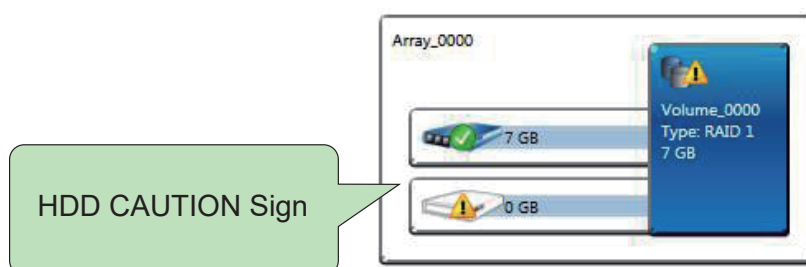

C.9 Recovery and Auto Re-build When Using the SAME RAID HDD

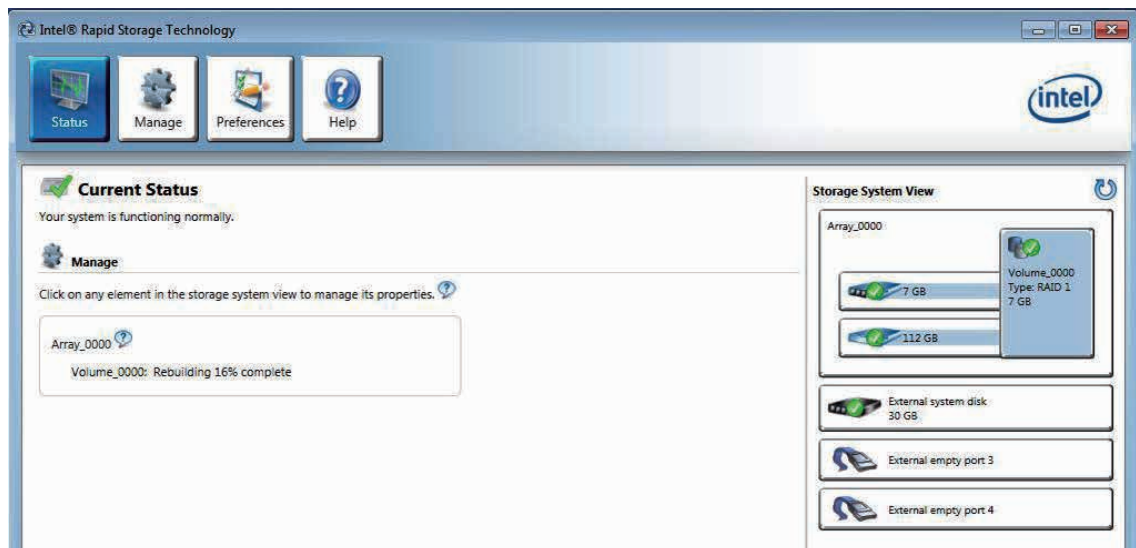

C.10 Recovery and Auto Re-build When Using DIFFERENT RAID HDD

There is a warning will pop-up to ask you if the disk is not a member of original RAID volume.

If you press “Rebuild”, it will replace the broken SATA HDD to the last one SATA HDD of RAID volume.

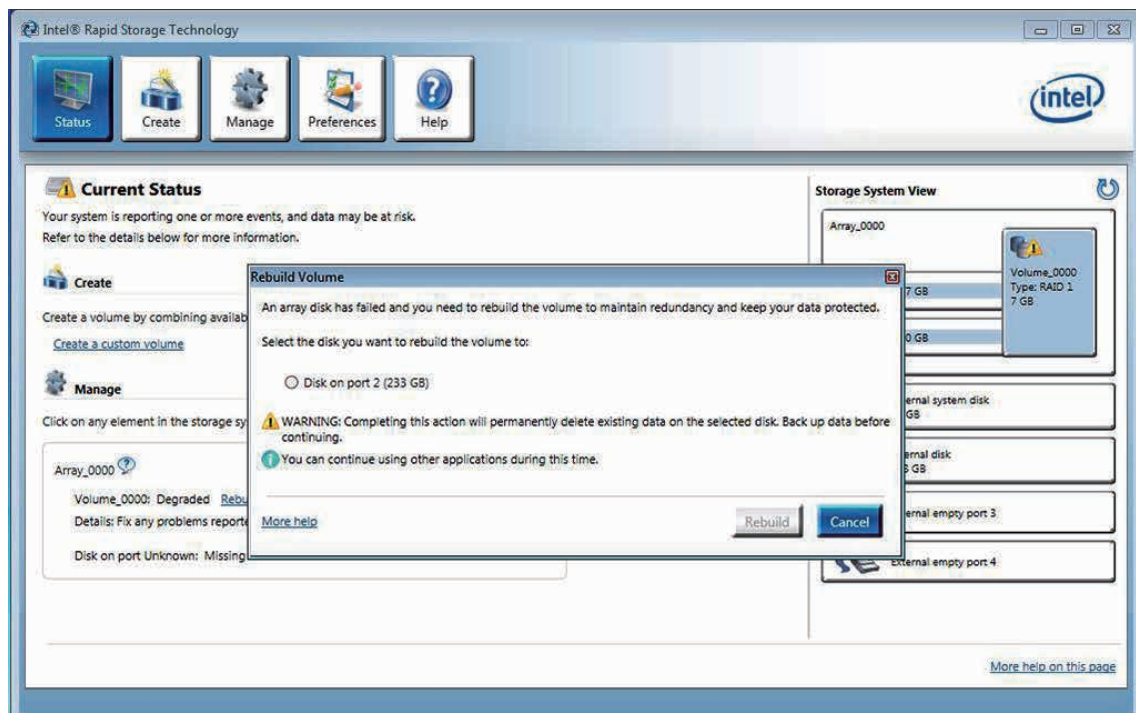

D

APPENDIX D : Power Consumption

Testing Board	ARS-2000
RAM	MEMXPRO DD4-2400 16GBx2
USB-1	Transcend USB 3.0 8GB
USB-2	Transcend USB 3.0 8GB
USB-3	Transcend USB 3.0 8GB
USB-4	ASUS USB mouse
CFAST	Transcend CFX600
SATA 0	MEMXPRO M3A 128GB
SATA 0	MEMXPRO M3A 512GB
LAN 1 (i219)	1.0 Gbps
LAN 2 (i210)	1.0 Gbps
LAN 2 (i210)	1.0 Gbps
Graphics Output	DVI
Power Plan	Balance (Windows10 Power Plan)
Power Source	Chroma 62006P-100-25

D.1 Intel® Core™ i7-6600U (4M Cache, 3.4 GHz)

Power on and boot to Win 10 64-bit

CPU	Power Input	Sleep Mode		Idle Status : CPU usage less 3%	
		Max Current	Max Consumption	Max Current	Max Consumption
i7-6600U	09V	0.519A	04.67W	1.542A	13.88W
i7-6600U	12V	0.454A	05.45W	1.118A	13.42W
i7-6600U	24V	0.230A	05.52W	0.578A	13.87W
i7-6600U	36V	0.179A	06.44W	0.378A	13.61W

CPU	Power Input	Run 100% CPU usage without 3D		Run 100% CPU usage with 3D	
		Max Current	Max Consumption	Max Current	Max Consumption
i7-6600U	09V	2.915A	26.24W	4.188A	37.69W
i7-6600U	12V	2.201A	26.41W	3.095A	37.14W
i7-6600U	24V	1.142A	27.41W	1.602A	38.45W
i7-6600U	36V	0.756A	27.22W	1.063A	38.26W

D.2 Intel® Core™ i5-6300U (3M Cache, 3.0 GHz)

Power on and boot to Win 10 64-bit

CPU	Power Input	Sleep Mode		Idle Status : CPU usage less 3%	
		Max Current	Max Consumption	Max Current	Max Consumption
i5-6300U	09V	0.505A	04.55W	1.378A	12.40W
i5-6300U	12V	0.451A	05.41W	1.078A	12.94W
i5-6300U	24V	0.219A	05.26W	0.516A	12.38W
i5-6300U	36V	0.172A	06.19W	0.348A	12.53W

CPU	Power Input	Run 100% CPU usage without 3D		Run 100% CPU usage with 3D	
		Max Current	Max Consumption	Max Current	Max Consumption
i5-6300U	09V	2.488A	22.39W	3.673A	33.06W
i5-6300U	12V	2.193A	26.32W	2.723A	32.68W
i5-6300U	24V	1.118A	26.83W	1.399A	33.58W
i5-6300U	36V	0.749A	26.96W	0.922A	33.17W

D.3 Intel® Core™ Celeron® 3955U (2M Cache)

Power on and boot to Win 10 64-bit

CPU	Power Input	Sleep Mode		Idle Status : CPU usage less 3%	
		Max Current	Max Consumption	Max Current	Max Consumption
Celeron® 3955U	09V	0.531A	04.78W	1.298A	11.68W
Celeron® 3955U	12V	0.458A	05.50W	1.053A	12.64W
Celeron® 3955U	24V	0.226A	05.42W	0.516A	12.38W
Celeron® 3955U	36V	0.177A	06.37W	0.338A	12.17W

CPU	Power Input	Run 100% CPU usage without 3D		Run 100% CPU usage with 3D	
		Max Current	Max Consumption	Max Current	Max Consumption
Celeron® 3955U	09V	2.198A	19.78W	3.066A	27.59W
Celeron® 3955U	12V	1.747A	20.96W	2.328A	27.94W
Celeron® 3955U	24V	0.883A	21.19W	1.178A	28.27W
Celeron® 3955U	36V	0.606A	21.81W	0.800A	28.79W

E

APPENDIX E : Supported Memory & Storage List

E.1 Supported Memory List

Testing Board	ARS-2000
CPU	i7-6600U
Memory Test	version: 5.1
BurnInTest	V8.1

E.2 Test Item

Channel	Memory Test	Burn In	Flash BIOS	Remove Battery
*2	PASS	PASS	PASS	PASS
*1(Socket 1)	PASS	PASS	N/A	PASS
*1(Socket 2)	PASS	PASS	N/A	PASS

E.3 NON-ECC

Brand	Info	Channel	NOTE & S/N	Test Temp. (Celsius)
Kingston	16GB 2Rx8 2Gx64-Bit PC4-2133	*2	KVR21S15D8/16	25°C
		*1(Socket 1)	BKMM1641607	25°C
		*1(Socket 2)	BKMM1661618	25°C
Memxpro	4GB DDR4- 2133-15 Wild Temp.	*2	D4S4GHIOFEI	25°C
		*1(Socket 1)	01611170040001	25°C
		*1(Socket 2)	01611170040002	25°C
Memxpro	8GB DDR4- 2133-15 Wild Temp.	*2	D4S8GHIOFFI	25°C
		*1(Socket 1)	01611150020001	25°C
		*1(Socket 2)	01611150020002	25°C
Memxpro	8GB DDR4- 2400-17- Wild Temp.	*2	D4S8GHLPGEI	85°C
		*1(Socket 1)	01611170030001	85°C
		*1(Socket 2)	01611170030002	85°C
Memxpro	16GB DDR4- 2400-17	*2	D4SAGHLPGFC	25°C
		*1(Socket 1)	01611150030003	25°C
		*1(Socket 2)	01611150030004	25°C
Memxpro	8GB DDR4- 2400-17	*2	D4S8GHLPGEC	25°C
		*1(Socket 1)	01611170030003	25°C
		*1(Socket 2)	01611170030004	25°C
Memxpro	8GB DDR4- 2133-15	*2	D4S8GHIOFFC	25°C
		*1(Socket 1)	01611150020003	25°C
		*1(Socket 2)	01611150020004	25°C
Memxpro	4GB DDR4- 2133-15	*2	D4S4GHIOFEC	25°C
		*1(Socket 1)	01611170040003	25°C
		*1(Socket 2)	01611170040004	25°C
Transcend	16G 2Rx8 DDR4 2133 SO	*2	TS0CASGSB0000	25°C
		*1(Socket 1)	D20478-0004	25°C
		*1(Socket 2)	D20478-0004	25°C

E.4 ECC

Brand	Info	Channel	NOTE & SN	Test Temp. (Celsius)
Transcend	8GB ECC Wild Temp.	*2	8G 2Rx8 DDR4 2133 ECCSO	25°C
		*1(Socket 1)	C94147-0001	25°C
		*1(Socket 2)	C94147-0002	25°C

E.5 Supported Storage Device List

Type	Brand	Model	Capacity
mSATA	Intel	Intel-310 SSDMAEMC080G2	80GB
SATA SSD	Transcend	SSD370 TS64GSSD370	64GB
	MEMXPRO	SSD M3A MI3MA1212802WN	128GB
		SSD M3A MI3MA1225604WN	256GB
		SSD M3A MI3MA1251208WN	512GB
		SSD Lite M3B MI3MB0132G02SN-AH	32GB
		SSD Lite M3B MI3MB1112802SN-AH	128GB
		SSD Lite M3B MI3MB1125604WN	256GB

F

APPENDIX F : Install Win11 (BIOS TPM Setting)

Step 1 Click on “Advanced”, then click on “PCH-FW Configuration”

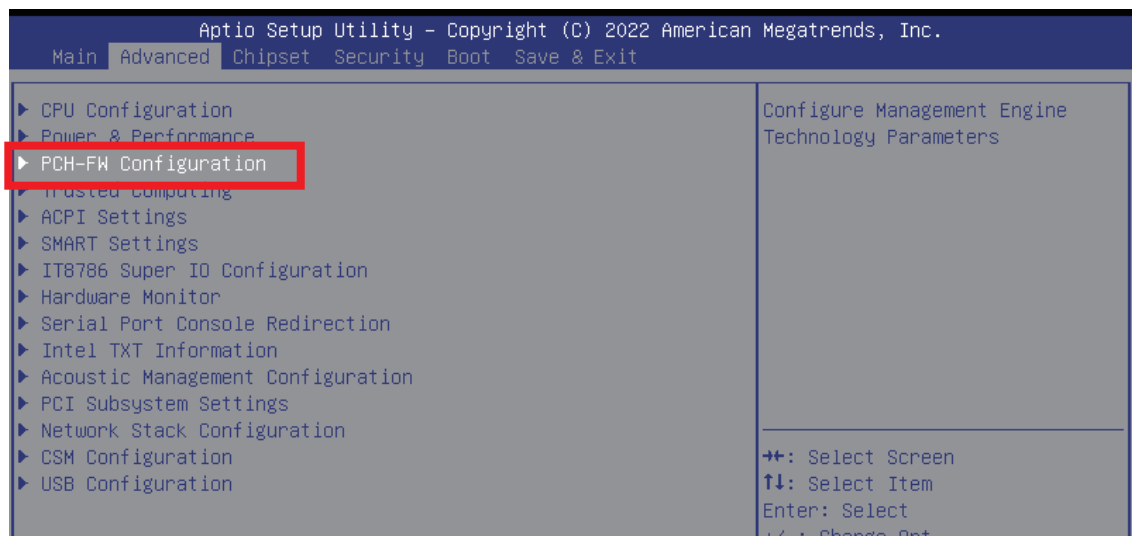

Step 2 Click on “PTT Configuration”

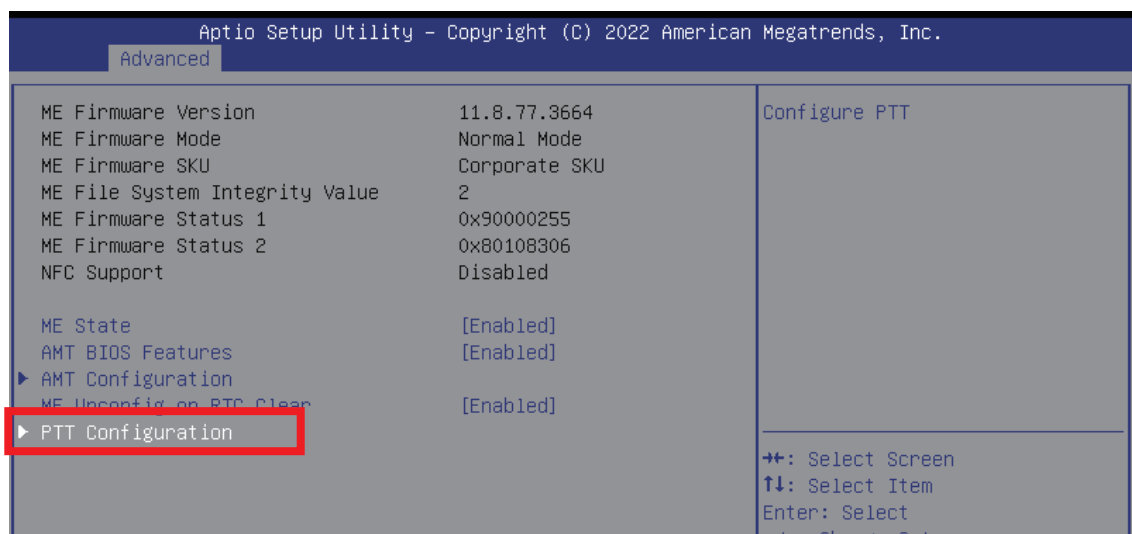

Step 3 Click on “dTPM” (TPM Device Selection)

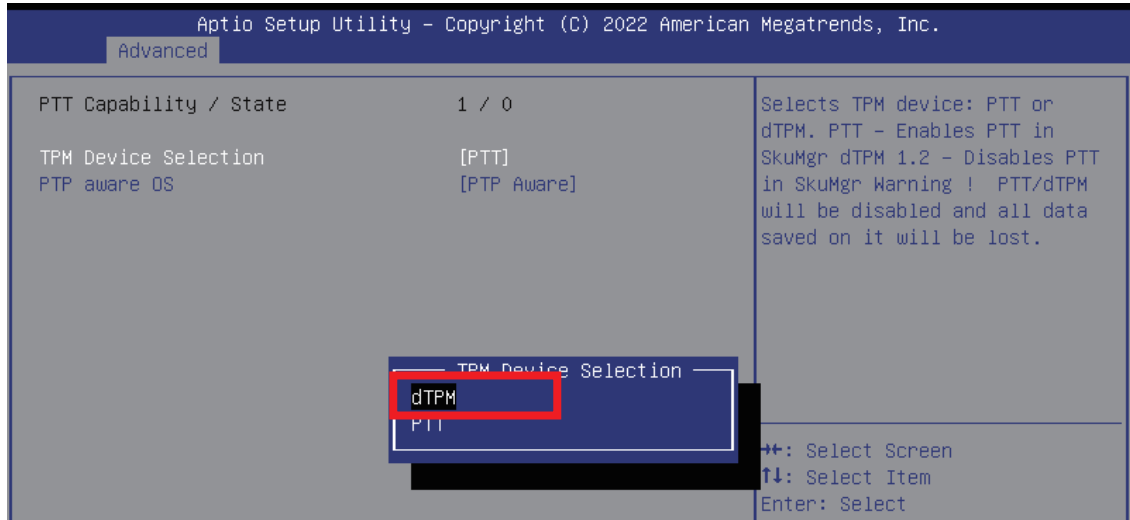

Step 4 Please save the BIOS settings by pressing F4. Please press Enter when the pop-up window which asks “Save configuration and exit?” appears. The computer will then restart.

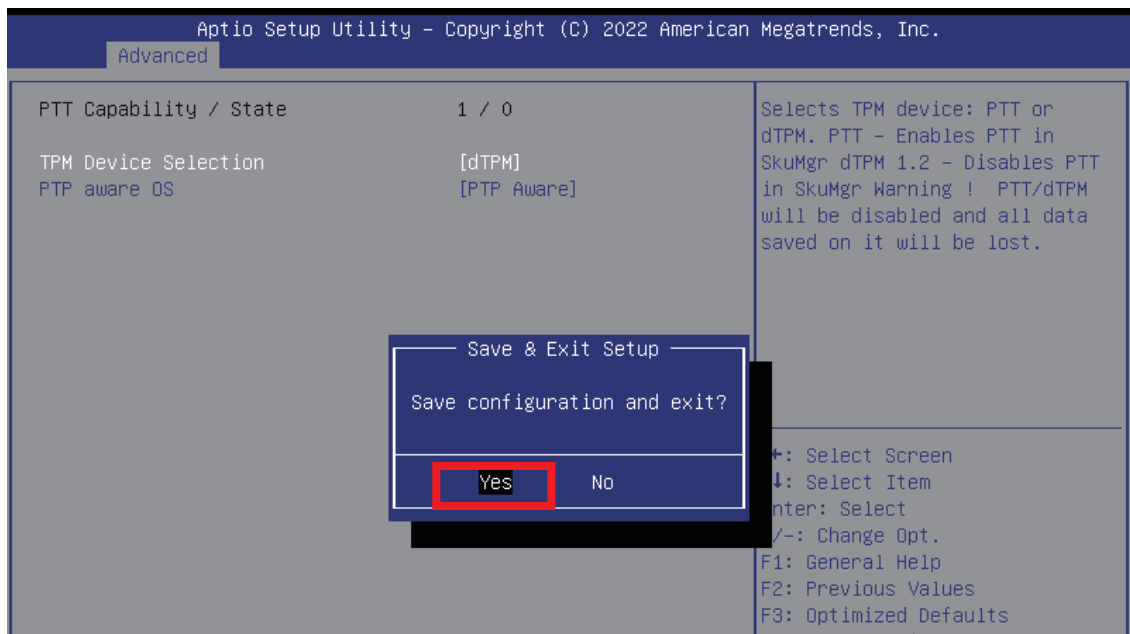

Step 5 Click on “Trusted Computing”

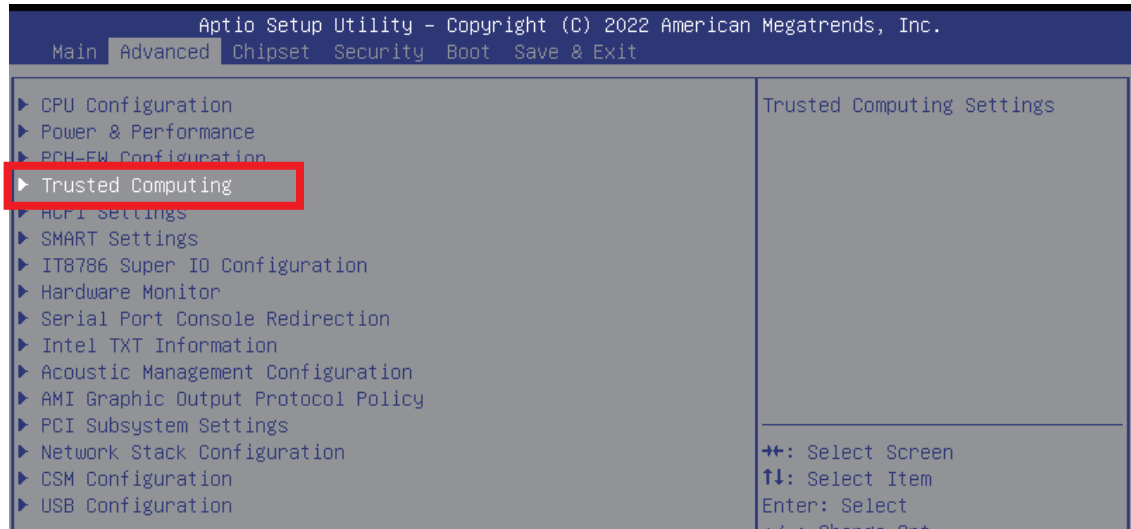

Step 6 If the window shows “TPM2.0 Device Found Firmware Version:5.62”, then the setting is completed.

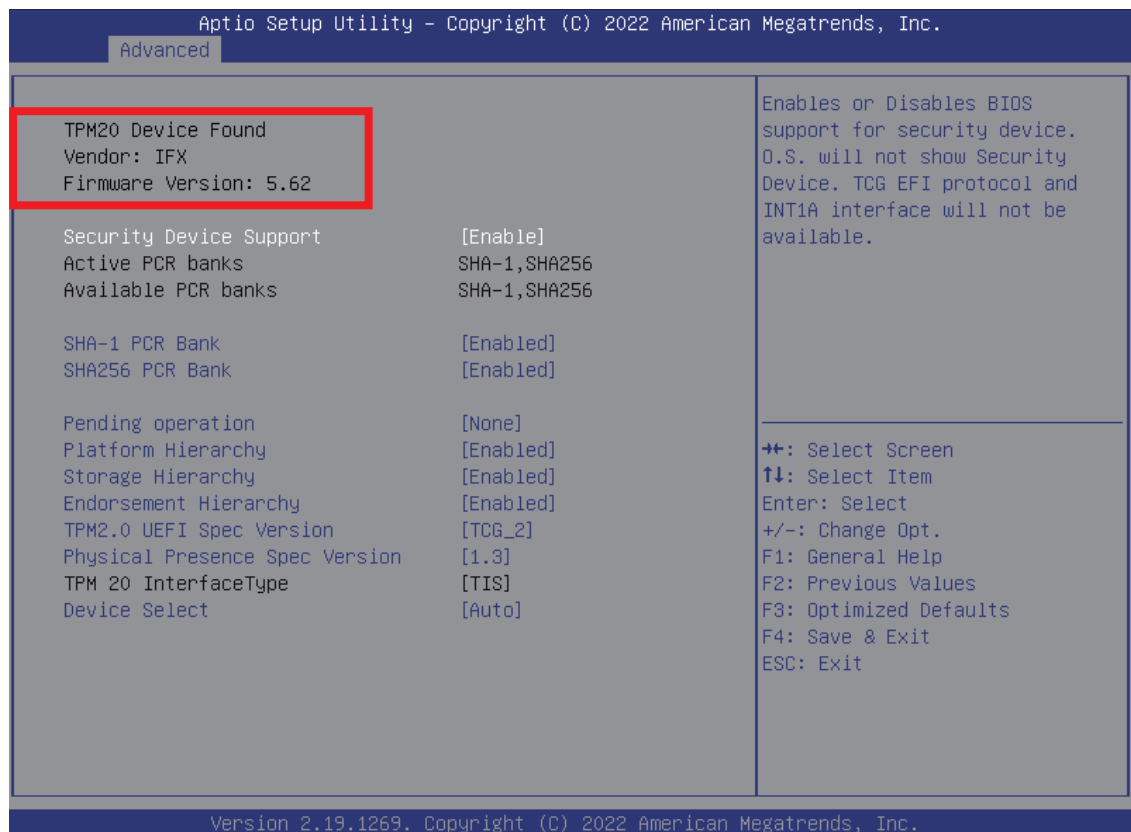

** If more help is needed, please contact Vecow technical support **



For further support information, please visit www.vecow.com

This document is released for reference purpose only.

All product offerings and specifications are subject to change without prior notice.

No part of this publication may be reproduced in any form or by any means, electric, photocopying, or recording, without prior authorization from the publisher.

The rights of all the brand names, product names, and trademarks belong to their respective owners.

© Vecow Co., Ltd. 2023. All rights reserved.